



NBS TECHNICAL NOTE 668

U.S. DEPARTMENT OF COMMERCE / National Bureau of Standards

**The Use of
National Bureau of Standards
High Frequency Broadcasts
for Time and Frequency Calibrations**

NATIONAL BUREAU OF STANDARDS

The National Bureau of Standards¹ was established by an act of Congress March 3, 1901. The Bureau's overall goal is to strengthen and advance the Nation's science and technology and facilitate their effective application for public benefit. To this end, the Bureau conducts research and provides: (1) a basis for the Nation's physical measurement system, (2) scientific and technological services for industry and government, (3) a technical basis for equity in trade, and (4) technical services to promote public safety. The Bureau consists of the Institute for Basic Standards, the Institute for Materials Research, the Institute for Applied Technology, the Institute for Computer Sciences and Technology, and the Office for Information Programs.

THE INSTITUTE FOR BASIC STANDARDS provides the central basis within the United States of a complete and consistent system of physical measurement; coordinates that system with measurement systems of other nations; and furnishes essential services leading to accurate and uniform physical measurements throughout the Nation's scientific community, industry, and commerce. The Institute consists of a Center for Radiation Research, an Office of Measurement Services and the following divisions:

Applied Mathematics — Electricity — Mechanics — Heat — Optical Physics — Nuclear Sciences² — Applied Radiation² — Quantum Electronics³ — Electromagnetics³ — Time and Frequency³ — Laboratory Astrophysics³ — Cryogenics³.

THE INSTITUTE FOR MATERIALS RESEARCH conducts materials research leading to improved methods of measurement, standards, and data on the properties of well-characterized materials needed by industry, commerce, educational institutions, and Government; provides advisory and research services to other Government agencies; and develops, produces, and distributes standard reference materials. The Institute consists of the Office of Standard Reference Materials and the following divisions:

Analytical Chemistry — Polymers — Metallurgy — Inorganic Materials — Reactor Radiation — Physical Chemistry.

THE INSTITUTE FOR APPLIED TECHNOLOGY provides technical services to promote the use of available technology and to facilitate technological innovation in industry and Government; cooperates with public and private organizations leading to the development of technological standards (including mandatory safety standards), codes and methods of test; and provides technical advice and services to Government agencies upon request. The Institute consists of a Center for Building Technology and the following divisions and offices:

Engineering and Product Standards — Weights and Measures — Invention and Innovation — Product Evaluation Technology — Electronic Technology — Technical Analysis — Measurement Engineering — Structures, Materials, and Life Safety⁴ — Building Environment⁴ — Technical Evaluation and Application⁴ — Fire Technology.

THE INSTITUTE FOR COMPUTER SCIENCES AND TECHNOLOGY conducts research and provides technical services designed to aid Government agencies in improving cost effectiveness in the conduct of their programs through the selection, acquisition, and effective utilization of automatic data processing equipment; and serves as the principal focus within the executive branch for the development of Federal standards for automatic data processing equipment, techniques, and computer languages. The Institute consists of the following divisions:

Computer Services — Systems and Software — Computer Systems Engineering — Information Technology.

THE OFFICE FOR INFORMATION PROGRAMS promotes optimum dissemination and accessibility of scientific information generated within NBS and other agencies of the Federal Government; promotes the development of the National Standard Reference Data System and a system of information analysis centers dealing with the broader aspects of the National Measurement System; provides appropriate services to ensure that the NBS staff has optimum accessibility to the scientific information of the world. The Office consists of the following organizational units:

Office of Standard Reference Data — Office of Information Activities — Office of Technical Publications — Library — Office of International Relations.

¹ Headquarters and Laboratories at Gaithersburg, Maryland, unless otherwise noted; mailing address Washington, D.C. 20234.

² Part of the Center for Radiation Research.

³ Located at Boulder, Colorado 80302.

⁴ Part of the Center for Building Technology.

The Use of National Bureau of Standards High Frequency Broadcasts for Time and Frequency Calibrations

N. Hironaka
C. Trembath

Time and Frequency Division
Institute for Basic Standards
National Bureau of Standards
Boulder, Colorado 80302



U.S. DEPARTMENT OF COMMERCE, Rogers C.B. Morton, Secretary

NATIONAL BUREAU OF STANDARDS, Richard W. Roberts, Director

Issued May 1975

National Bureau of Standards Technical Note 668

Nat. Bur. Stand. (U.S.), Tech Note 668, 47 pages (May 1975)

CODEN: NBTNAE

For sale by the Superintendent of Documents, U.S. Government Printing Office, Washington, D.C. 20402
(Order by SD Catalog No. C13.46:668) \$1.05

FORWARD

This work was carried out under NBS project 2770419 and sponsored in part with funds under Contract Number EIIIM-6, March 1971, from HQ AFCS/EPECC, Richards-Gebaur AFB, Missouri 64030.

CONTENTS

	<u>Page</u>
1. INTRODUCTION	1
2. NBS HIGH FREQUENCY BROADCASTS	1
2.1 General	1
2.2 Broadcast Format	2
3. WWV/WWVH TIME INTERVAL BROADCASTS	3
3.1 General	3
3.2 Direct Trigger Method of Time Synchronization.	3
3.3 Delayed Trigger Method of Time Synchronization	6
3.4 Photograph Tick Averaging Method of Time Synchronization	9
4. USE OF WWV/WWVH BROADCASTS FOR FREQUENCY CALIBRATIONS	9
4.1 General Considerations for Frequency Calibrations	9
4.2 Beat Frequency Method of Frequency Calibration	10
4.3 Oscilloscope Lissajous Pattern Method of Frequency Calibration	13
4.4 Oscilloscope Pattern Drift Method of Frequency Calibration	15
4.5 Frequency Calibrations by Time Comparison of Clocks	16
5. RESULTS OF TIME COMPARISONS	17
6. APPENDIX	20
6.1 Receiver Selection and Antenna Choices	20
a. WWV/WWVH Receiver	20
b. WWV/WWVH Receiving Antennas	21
(1) 2.5 MHz	22
(2) 5.0 MHz	22
(3) 10.0 MHz	22
(4) 15.0 MHz	24
(5) 20.0 MHz	24
(6) 25.0 MHz	24
(7) Directional Antenna	24
6.2 Receiver Time Delay Measurements	26
6.3 Great Circle Distance Calculations	27
6.4 Propagation Delay Computations.	29
6.5 Adjustable Time Delay Generator	37
a. Decade Counters	37
b. Count Selection and Logic Group	37
c. Starting and Resetting Group	39
d. Output Pulse Shaping and Inverter Group	41
7. ACKNOWLEDGEMENT	41
8. REFERENCES	41

LIST OF FIGURES

	<u>Page</u>
Table 1: WWV TO WWVH PROPAGATION DELAY	19
Figure 1: WWV and WWVH seconds pulses	2
Figure 2: Block diagram of equipment connection for direct trigger method of time synchronization	3
Figure 3: Oscilloscope display of WWV tick at a sweep rate of 0.2 s/division	5
Figure 4: Oscilloscope display of WWV tick at a sweep rate of 0.1 s/division	5
Figure 5: Oscilloscope display showing leading edge of WWV tick at a sweep rate of 5 ms/division	5
Figure 6: Oscilloscope display showing second zero crossover of seconds pulse at a sweep rate of 1 ms/division	5
Figure 7: Equipment setup for delayed trigger method of time synchronization	7
Figure 8: Oscilloscope display showing second zero crossover of WWV tick at a sweep rate of 1 ms/division using delayed trigger method.	8
Figure 9: Oscilloscope display showing second zero crossover of WWV tick at a sweep rate of 100 μ s/division using delayed trigger method.	8
Figure 10: Oscilloscope display showing WWV tick at a sweep rate of 1 ms/division using photographic tick averaging method	9
Figure 11: Oscilloscope display of WWV tick at a sweep rate of 100 μ s/division using photographic tick averaging method	9
Figure 12: Equipment setup for beat frequency method of calibration	10
Figure 13: Diode clipping circuit to produce harmonics from a pure sine wave signal	11
Figure 14: Oscilloscope display showing Lissajous pattern	14
Figure 15: Oscilloscope display using pattern drift method	16
Figure 16: Data plots, propagation time delay (TD_p) between WWV and WWVH	18
Figure 17: Block diagram of typical high performance HF receiver	20
Figure 18: Quarter-wavelength vertical antenna and horizontal half-wavelength antenna	23
Figure 19: Modified half-wavelength vertical antenna for use at 15, 20, and 25 MHz	25
Figure 20: Typical Yagi antenna design	25
Figure 21: Equipment setup for receiver time delay measurements	26
Figure 22: Oscillogram of delayed and undelayed 1 kHz signal	27
Figure 23: Diagram for great circle distance calculations	28
Figure 24: Reflection of radio waves at different ionized layer heights	29
Figure 25: Single-hop reflections from F_2 layer at different wave angles	30
Figure 26: Single-hop transmission at different wave angles	31
Figure 27: Multihop signal that has a too low angle of radiation	31
Figure 28: Retardation or slow down of radio waves as they pass through different ionized layers	32
Figure 29: Illustration showing derivation of wave angles	33
Figure 30: Controlled delay generator logic diagram	38
Figure 31: Controlled delay generator wiring diagram	40

THE USE OF NATIONAL BUREAU OF STANDARDS HIGH FREQUENCY
BROADCASTS FOR TIME AND FREQUENCY CALIBRATIONS

by

N. Hironaka and C. Trembath

ABSTRACT

Methods to determine time or frequency by reception of NBS high frequency radio broadcasts are discussed. Results are shown for calibration of time signals to within ± 100 microseconds and calibration of frequency offset with a resolution of better than 1 part in 10^9 . These results are achieved by using a systematic approach and refined measurement technique.

Key Words: Dissemination; frequency; high frequency broadcasts; standard; time

1. INTRODUCTION

The purpose of this report is to present methods to make time and frequency calibrations by reception of high frequency (HF) radio broadcasts from the National Bureau of Standards (NBS) radio stations WWV [1] and WWVH [2, 3]. While general measurement methods have appeared in the literature [4, 5, 6, 7], specific techniques are described here.

Special emphasis is placed on procedures for field use to measure or set clocks with resolutions of ± 100 microseconds and to calibrate frequency to parts in 10^{10} . These values are better than previously reported [8] since a more systematic approach is used with results averaged over more than one measurement.

The importance of HF methods has been overshadowed by advances in very low frequency (VLF) techniques [9] and TV time and frequency comparison. Nevertheless, the ease, simplicity, and economy of using HF broadcasts, along with the fact that date/time transfer to 1 millisecond resolution can be made in a few minutes measurement time, illustrates the importance and popularity of HF broadcasts. Although results depend heavily on reception conditions, distance from the transmitting station, and time of day, stated measurement resolution is obtainable when path delay is known.

2. NBS HIGH FREQUENCY BROADCASTS

2.1 General

High frequency radio signals such as those from radio stations WWV/WWVH rely primarily on reflection from the ionosphere to arrive at a distant point. Variations in the density and height of the ionosphere (or reflecting region) cause corresponding variations in the path length of a received signal. This can be observed as fading of a received signal and changes in delay time of a received pulse or "tick." The arrival time of a timing pulse may vary from day to day, even for measurements made at the same time of day. Variations can be averaged by measurements taken each day and recorded over several days.

Good reception of signals; i.e., a good signal-to-noise (S/N) ratio from WWV/WWVH is essential for high resolution frequency or time measurement. Received field strength and geographical location will determine the necessary receiver and antenna requirements. For example, a directional antenna may be necessary so that it can be oriented to favor the transmission mode which consistently provides the strongest received signal.

2.2 Broadcast Format

Standard time and frequency stations WWV and WWVH derive their signals from a cesium beam frequency standard. They each use three "atomic clocks" to provide the time of day, audio tones, and carrier frequencies as broadcast. The frequencies of the cesium standards at the stations are controlled to be within $\pm 1 \times 10^{-12}$ of the NBS frequency standard located in Boulder, Colorado. Time at the stations is controlled to within ± 5 microseconds of the UTC(NBS) time scale.

The cesium standards drive time code generators through various dividers, multipliers, and distribution amplifiers. The time code generators generate the familiar audio tones and time ticks. Frequency synthesizers provide the clear channel radio frequencies with appropriate amplitude modulation.

The seconds pulses or "ticks" transmitted by WWV and WWVH are derived from the same frequency standard that controls the carrier frequencies. They are produced by a double sideband, 100 percent modulated signal on each RF carrier and consist of a 5 millisecond pulse of 1000 Hz (5 cycles) at WWV and 1200 Hz (6 cycles) at WWVH commencing at the beginning of each second as shown in figure 1. A tone burst of 0.8 second duration (1000 Hz for WWV and 1200 Hz for WWVH) begins each minute instead of the tick. Each tick is preceded by 10 milliseconds of silence and followed by 25 milliseconds of silence. Voice announcements are thus interrupted each second for a duration of 40 milliseconds with only small degradation in intelligibility.

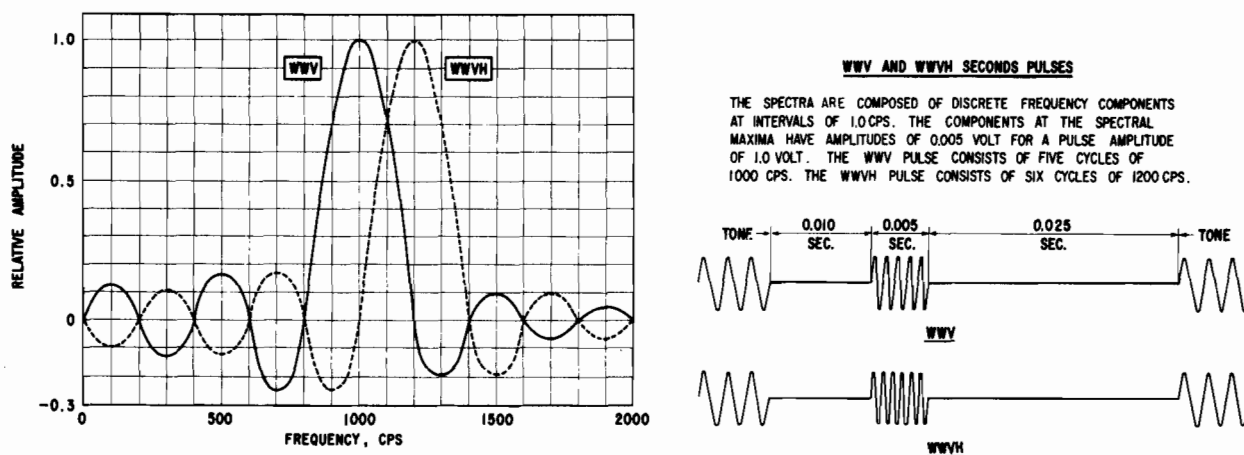

Figure 1. WWV and WWVH seconds pulses.

Transmitting equipment at each station consists of high-power linear amplifiers which are connected to appropriate antenna systems. The WWVH antennas are directional arrays except for a 2.5 MHz monopole while the antennas at WWV are omni-directional. The directional property of the WWVH antennas is intended to minimize "interference" between the two stations and to enhance radiation to the far Western Pacific.

3. WWV/WWVH TIME INTERVAL BROADCASTS

3.1 General

This section describes three methods to determine time of day or time interval with resolutions better than 1 millisecond (1000 microseconds). Under favorable propagation conditions, it is possible to establish time synchronization to better than 100 microseconds (see Section 5). The methods are: (1) direct trigger, (2) delayed trigger, and (3) photographic averaging. Techniques used in the direct trigger method are fundamental to the other two. In each case, path and equipment time delay measurements are necessary for accurate results.

In order to achieve optimum results in any of these measurement methods, the following guidelines are recommended:

1. Carry out measurements at exactly the same time every day.
2. Avoid twilight hours when the ionosphere is the least stable.
3. Choose the highest frequency which provides consistently good reception.
4. Observe the received signals on the oscilloscope for a few minutes to judge the stability of propagation conditions and select that portion of the timing waveform that is most consistent.

Since time delay is so important, an Appendix is included to aid in the determination of equipment and propagation time delay.

3.2 Direct Trigger Method of Time Synchronization

The direct trigger method is the simplest and requires only the following equipment: (1) an oscilloscope with external sweep trigger and accurately calibrated time base, and (2) WWV/WWVH receiver with audio output. Equipment connection is shown in figure 2.

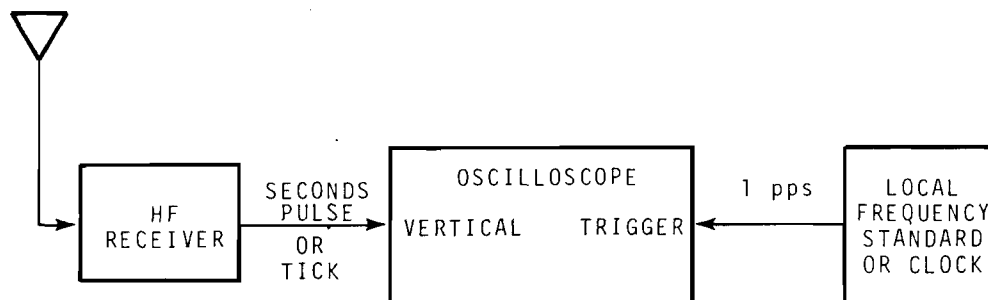

Figure 2. Block diagram of equipment connection for direct trigger method of time synchronization.

A local clock pulse at a once per second rate is used to trigger the oscilloscope sweep. At some time interval later during the sweep, the WWV/WWVH seconds pulse appears on the display as shown in figure 3. The time interval from the start of the sweep to the point where the WWV/WWVH tick appears is the total time difference between the local clock and WWV/WWVH. By subtracting the propagation time delay and the receiver time delay from the measured value, the local clock time error from WWV/WWVH can be determined. The equation to determine time error at a receiving location is:

$$\text{Time Error} = t_r - t_t = \text{TD} - (\text{TD}_p + \text{TD}_r),$$

Where: t_r = time of receiving station
 t_t = time of transmitting station (WWV/WWVH)
 TD = total time difference (measured)
 TD_p = propagation path time delay
 TD_r = receiver time delay

To synchronize a local clock with the WWV/WWVH time signal, the local clock rate must be adjustable so its tick can be advanced or retarded. The receiver is tuned to WWV/WWVH and the oscilloscope sweep rate set at 0.1 s/division. The WWV/WWVH tick will typically appear as shown in figure 4. If the tick is one division or more from the left side of the scope display, the time of the local clock is corrected until the WWV/WWVH tick falls within the first division from the left side. If the local time tick is late, the WWV/WWVH tick will be heard before the sweep starts. If this is the case, the local clock should be advanced until the tick appears. After the local seconds pulse has been properly adjusted and appears within the first division (0.1 second in time), the sweep rate is increased to, say, 5 ms/division. Using this greater resolution, the local clock is adjusted until the leading edge of the WWV/WWVH pulse starts at a time equal to the propagation delay time plus the receiver delay time after the trigger as shown in figure 5.

The sweep rate should be expanded to the highest rate possible without allowing the total sweep time to become less than the combined propagation and receiver delay time less the 5 milliseconds to compensate for length of the received seconds pulse.

With a sweep rate of 1 ms/division, for example, greater resolution can be realized by measuring the second zero crossover point of the 5 ms received tick. Although the leading edge of the seconds pulse as broadcast from these stations is "on time," coincident with UTC(NBS), it is difficult to measure because of the slow rise time at the beginning of the burst and undulations due to propagation anomalies. For this reason, the second zero crossover (first positive-going crossover) should be used. The second zero crossover of the WWV pulse is delayed exactly 1000 microseconds and the WWVH seconds pulse is delayed 833 microseconds as shown in figure 6. This is called the cycle correction.

At a sweep rate of 1 ms/division, the variation in arrival time (jitter) is readily apparent. After observing the pulses for a period of a minute or two, select the cycle that is undistorted and relatively larger in amplitude. In determining the time at a receiving location to include the delay of the chosen zero crossover point, add the cycle correction to the propagation and equipment delay using the following relationship:

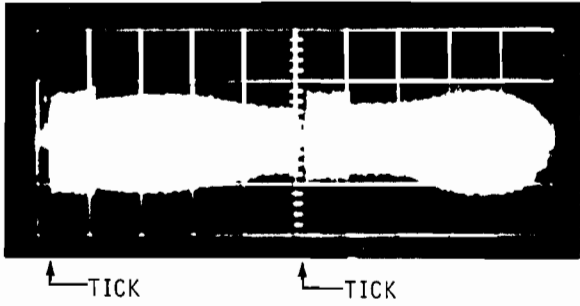

Figure 3. Oscilloscope display of WWV tick at a sweep rate of 0.2 s/division

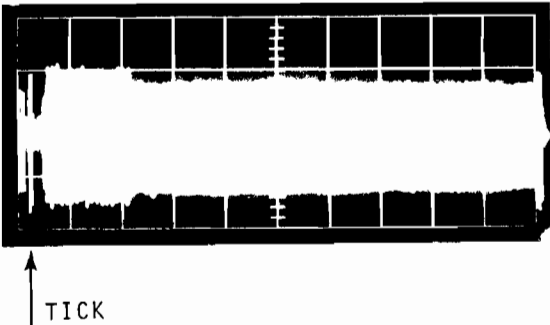

Figure 4. Oscilloscope display of WWV tick at a sweep rate of 0.1 s/division

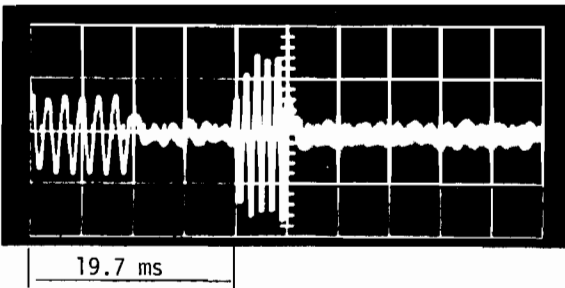
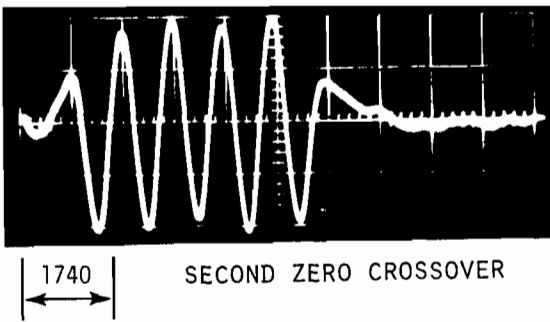

Figure 5. Oscilloscope display showing leading edge of WWV tick at a sweep rate of 5 ms/division

Total time delay = 19.7 ms



WWV time tick:
Trigger time delay: 19,000 microseconds
Total time delay: 20,740 microseconds

Figure 6. Oscilloscope display showing second zero crossover of seconds pulse at a sweep rate of 1 ms/division

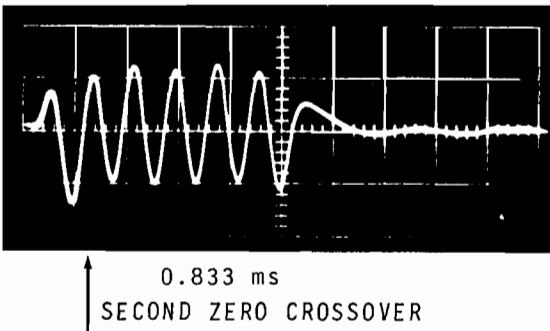

WWVH tick received 2 miles away:
Receiver delay: 320 microseconds
Total time delay: 1.160 milliseconds

$$\text{time error} = t_r - t_t = TD - (TD_p + TD_r + \text{cycle correction})$$

$$\begin{aligned} \text{Where cycle correction time} &= 1000 \text{ microseconds per cycle (WWV)} \\ &= 833 \text{ microseconds per cycle (WWVH)} \end{aligned}$$

As an example, assume an operator at a distant receiver location is interested in comparing his time to that of WWVH. The propagation and receiver delay time was measured as 11.7 milliseconds and 300 microseconds respectively. Since the total delay is 12.0 milliseconds (11.7 ms + 0.3 ms), set the oscilloscope sweep rate at 2 ms/division for a total sweep time of 20 ms--slightly greater than the propagation delay + receiver delay + 5 ms total. The second zero crossover of the tick was observed and measured 12.5 ms after the sweep was triggered by the station clock.

From these data, the time at the receiver site is calculated and is equal to -0.333 ms (late) with respect to the WWVH (UTC) time as broadcast, or:

$$\text{time error} = t_r - t_t = 12.5 - (11.7 + 0.3 + 0.833) = -0.333 \text{ ms, or } -333 \mu\text{s.}$$

$$\begin{aligned} \text{Where: } TD &= 12.5 \text{ ms} \\ TD_p &= 11.7 \text{ ms} \\ TD_r &= 0.3 \text{ ms} \end{aligned}$$

The one cycle correction for WWVH = 0.833 ms.

It will be noted that if a receiving station is located at a distance greater than 3,000 km (1863 miles) from the transmitter, the propagation time will exceed 10 ms. This forces the user to use a scope sweep time of 2 ms/division and lowers the measurement resolution. The next section describes a method of measurement to overcome this difficulty.

(The radio path delay works out to be about 5 μ s per mile. At 1863 miles, the delay would be at least 9.315 ms. It is greater than this due to the fact that HF radio signals bounce off the ionosphere.)

3.3 Delayed Trigger Method of Time Synchronization

To improve the resolution of measurement, the oscilloscope sweep must be operated as fast as possible. The user does have an option. Instead of depending on the calibrated sweep in the scope, he can generate a trigger pulse independent of his clock. He then positions the pulse for maximum sweep speed and makes his measurement. But then he must measure the difference between his clock and the delayed trigger pulse. Note: This can be accomplished by using an oscilloscope with a delayed sweep circuit built in or with an outboard trigger generator. The latter method is discussed here, but the delayed sweep scope could be used. Reference to the instrument manual will aid in using that technique.

The design for a controlled delay generator is presented in the Appendix. On this unit, a delay dial indicates the delay between the input local clock tick and the output trigger pulse. If the user already has a variable rate divider to produce delayed pulses, a time interval

counter could be used instead of the delay generator. In either case, the amount of trigger delay must be accounted for in measuring the total time delay (TD) of the received tick with respect to the local master clock.

The time of day the measurement is to be conducted should be established and adhered to for consistent results. Measurements should be made each day within 10 minutes of the designated time. A time of day should be selected when the midpoint of the transmitter-receiver path is near midday and, for night measurements, a time should be chosen when the midpoint of the path is near midnight. Measurements should not be made near twilight.

The equipment should be connected as shown in figure 7. A commercially available frequency divider and clock can be used in place of the controlled delay generator. A time interval counter is then used to measure the output of the delayed clock to the master clock. The output of the delayed clock is used to trigger the oscilloscope.

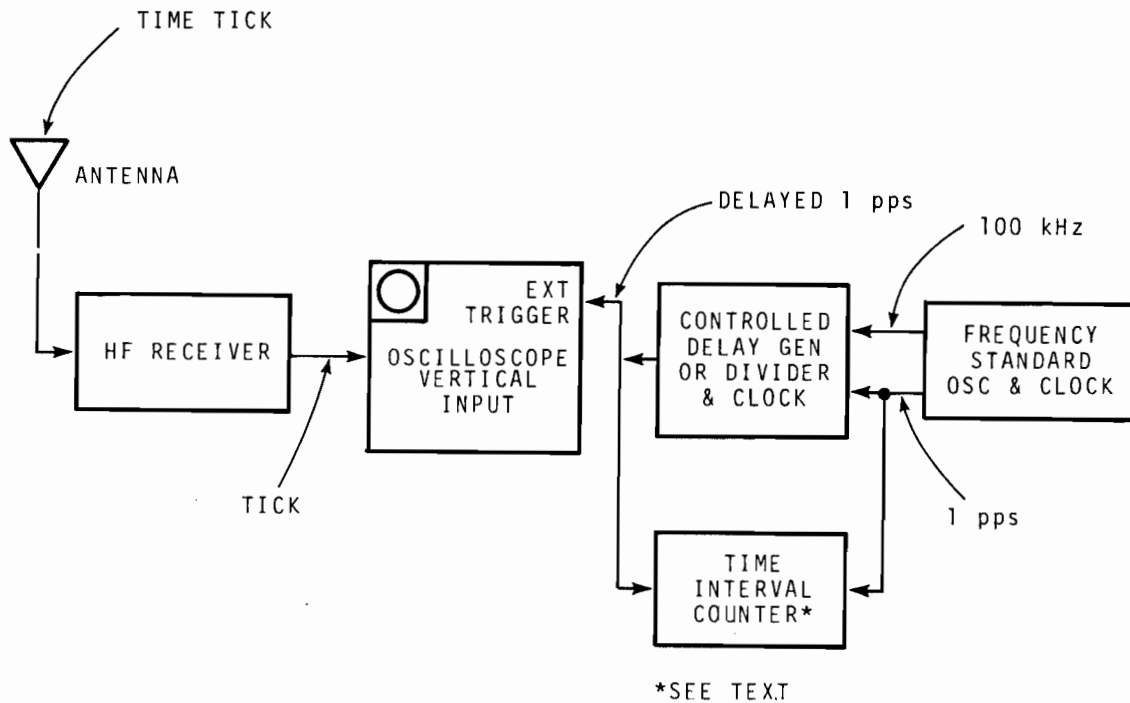

Figure 7. Equipment setup for delayed trigger method of time synchronization.

The initial procedures described in the direct trigger method also apply to this method and, therefore, should be referred to in setting time with WWV/WWVH.

With the oscilloscope sweep adjusted to 1 ms/division, the trigger pulse should be delayed from the delay generator or the delayed clock by an amount equal to the propagation delay in milliseconds. For the time being, any fractional milliseconds in the delay can be neglected. The sweep should be adjusted so that it begins exactly at the left end of the horizontal graticule and is vertically centered.

The second zero crossover point of the tick (figures 8, 9) should be observed and carefully measured. With the sweep at 1 ms/division, the delay of the second zero crossover on the oscilloscope is measured to the nearest one tenth of a millisecond and added to the trigger delay resulting in an approximate total time delay. If the local master clock 1 pps time is exactly coincident with the UTC(NBS) seconds pulse, the total measured time delay will be

approximately equal to the sum of the propagation delay time, the receiver delay time (approximately 200 - 500 μ s), and the cycle correction (1000 μ s for WWV, 833 μ s for WWVH).

To further increase the resolution of delay measurement, the oscilloscope sweep rate can be increased to 0.1 ms/division (100 μ s/division) and the trigger pulse from the generator adjusted to be approximately 500 microseconds less than the total delay time previously measured. At these settings, the second zero crossover of the tick will be somewhere near the midscale of the oscilloscope face.

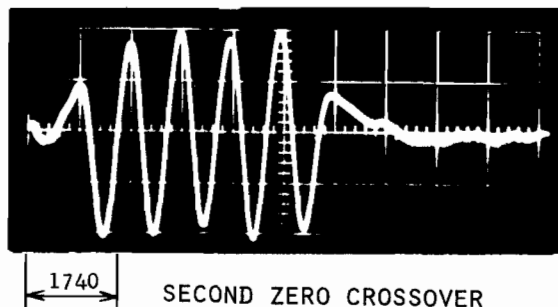

Figure 8. Oscilloscope display showing second zero crossover of WWV tick at a sweep rate of 1 ms/division

Trigger delay time: 19,000 μ s
Total time delay: 20,740 μ s

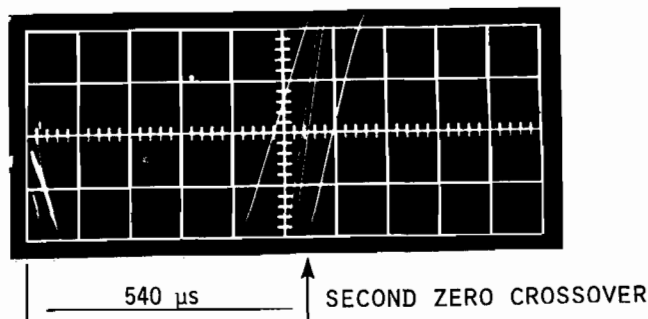

Figure 9. Oscilloscope display showing second zero crossover of WWV tick at a sweep rate of 100 μ s/division. (four sweeps)

Trigger delay time: 20,200 μ s
Total time delay: 20,740 μ s

The vertical centering of the sweep should be rechecked and centered if necessary. The tick is measured to the nearest 10 microseconds (figure 9). The result should be within ± 100 microseconds of the result obtained at the 1 ms/division sweep rate. If the result of this measurement falls outside this tolerance, then the procedure should be repeated by measuring the total time delay at a sweep rate of 1 ms/division.

To obtain the time with respect to WWV/WWVH or UTC(NBS), the equation given in the direct trigger method, described earlier, should be used.

If the average propagation delay time is not accurately known, it can be determined by initially setting the time accurately to the UTC(NBS) time with a portable clock measurement. However, by maintaining the time accurately for a month, the average propagation delay time can be established and, if time should be "lost" or disrupted, it can be reset again with WWV/WWVH using the average propagation delay value. If time is to be reset, the propagation delay on that day may be different from the average delay time and continuing daily measurements will result in a new average delay. Thus, the time will be slowly corrected so that the new average is again equal to the old average delay time.

3.4 Photographic Tick Averaging Method of Time Synchronization

By film recording five or more overlapping exposures of the WWV/WWVH tick, an average of the tick arrival time can be estimated with more accuracy. The exposures are made when consistently strong and undistorted ticks appear on the oscilloscope. To determine the time, the usual average of the second zero crossover point of the tick is measured using the same procedure explained on the direct trigger and delayed trigger methods.

In making measurements using this technique, an oscilloscope camera using self-developing film is desirable. The camera shutter is placed in the "B" position so that it can be opened and closed manually. The lens opening of the camera, the oscilloscope trace intensity, and the scale illumination must be determined by experiment.

The procedure described with the delayed trigger method is followed to obtain the WWV/WWVH tick. At a sweep rate of 1 ms/division, the shutter is opened before the sweep starts and closed after the sweep ends. This is repeated each second until five overlapping exposures are completed (figure 10). The pictures should be taken when the ticks begin to arrive with the least distortion and maximum amplitude.

This procedure can also be used at a faster sweep rate of 100 μ s/division with the second zero crossover point appearing approximately at midpoint of the trace. (One complete cycle of the tick should be visible--figure 11.) Five overlapping exposures of the ticks are taken and an average reading is obtained from the photograph.

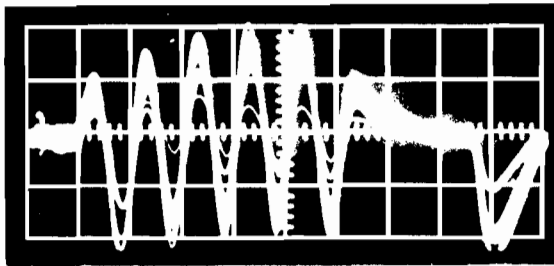

Figure 10. Oscilloscope display showing WWV tick at a sweep rate of 1 ms/division

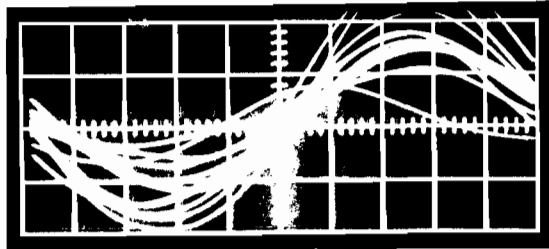

Figure 11. Oscilloscope display of WWV tick at a sweep rate of 100 microseconds/division

4. USE OF WWV/WWVH BROADCASTS FOR FREQUENCY CALIBRATIONS

4.1 General Considerations for Frequency Calibrations

In addition to the widely used time service of the two NBS HF radio stations, standard frequencies are also available to the broadcast listener. With a general purpose HF receiver capable of tuning these stations, a calibrating frequency is readily available for comparison and measurement.

At lower frequencies, say from 10 to 100 kHz, it is possible to record the phase difference between two frequencies. Two important broadcasts in this range are the NBS station WWVB and the Loran-C navigation signals. Phase recording is possible if the local standard is good

enough because the radio path at these low frequencies is very stable. Typically, the accumulated phase would be less than 100 microsecnds a day. For a signal at 100 kHz, this represents 10 cycles. Thus, a beat note technique, etc., would be unsuitable, so phase measurement is employed.

At higher radio frequencies, this is not the case. The propagation variations of HF signals and the relatively short wavelength prohibit phase comparison on a long-term basis. If a high frequency ground wave signal could be received, long-term phase comparison would be possible. However, ground waves are limited to an area at short distances from the transmitter because of high path attenuation and sky wave interference.

Direct frequency comparison or measurement with WWV can be accomplished to about one part in one million (1 part in 10^6). This resolution can be improved by long-term time comparison of clocks operated from a frequency source rather than direct frequency or phase comparison. Four methods of calibrating frequency sources using the broadcasts of WWV/WWVH will be discussed: (1) beat frequency method; (2) oscilloscope Lissajous pattern method; (3) oscilloscope drift pattern method; and (4) frequency calibrations by time comparisons.

4.2 Beat Frequency Method of Frequency Calibration

Beat frequency or heterodyne methods of frequency comparison with standard radio frequencies is a simple technique commonly used by radio operators to calibrate transmitters and tune receivers. Frequency offset of less than 1 part in 10^6 can be accurately determined. Thus, a 1 MHz signal that is calibrated in this way can have an expected error of 1 Hz.

Figure 12 shows an arrangement for calibrating a 100 kHz oscillator. A 100 kHz signal containing harmonics is coupled to the receiver input along with the signal from the antenna.

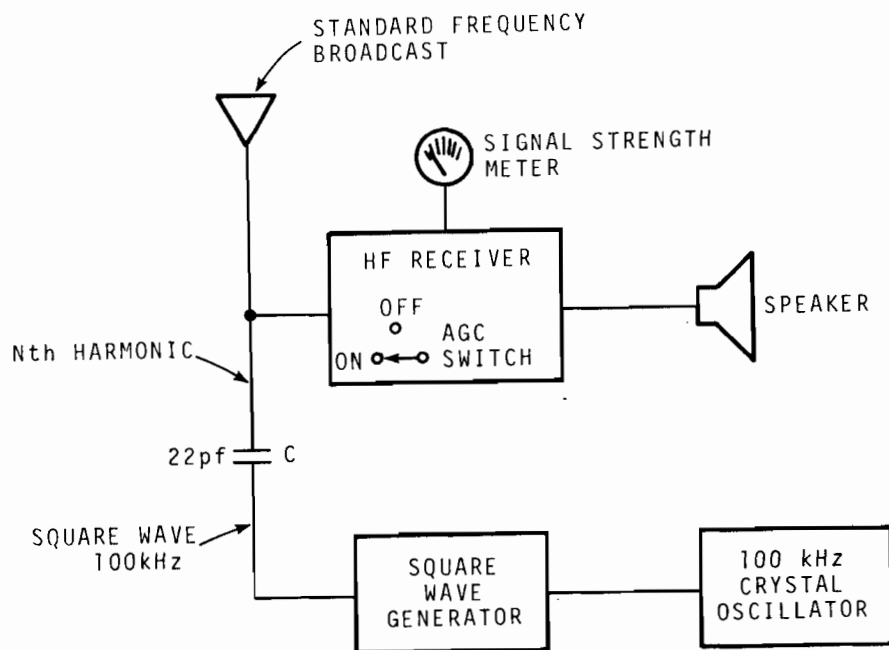

Figure 12. Equipment setup for beat frequency method of calibration.

This method consists of heterodyning or mixing a known and accurate frequency (WWV/WWVH RF signal) with the output of an oscillator. The mixing is accomplished by the converter circuit in any superheterodyne receiver. The difference frequency of the two RF signals can be amplified and detected. The result is an audio output signal called the beat frequency or beat note.

The frequency of this beat note is the difference of the two input RF frequencies. When the two frequencies are made equal, their difference decreases to zero and is called zero beat. Therefore, an oscillator can be set nearly equal to WWV in frequency.

To calibrate a frequency standard or crystal oscillator with an output frequency lower than that broadcast by WWV, the correct harmonic equal to the WWV signal is required. For example, if a 100 kHz signal is to be calibrated with the WWV 5 MHz carrier frequency, then it must also contain a harmonic fifty times itself. Thus, a signal to be calibrated must be a submultiple of the WWV carrier frequency.

Theoretically, a sine wave does not contain any harmonics. In practice, though, all sine wave signals contain some harmonics. Sufficient harmonic content is normally present to produce a beat note. A square wave signal, on the other hand, is very rich in harmonic content and is ideal for generating harmonics to calibrate receivers, transmitters, etc., in the HF and VHF band.

A simple method of generating a square wave from a sine wave is by clipping the signal with a diode clipping circuit shown in figure 13. To obtain a strong harmonic signal for beat notes, it requires a large amplitude signal to produce heavy clipping. A better method is to digitally divide the 100 kHz signal to produce square waves having closely spaced harmonics.

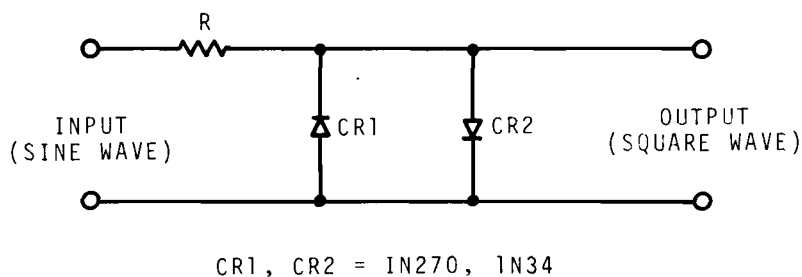

Figure 13. Diode clipping circuit to produce harmonics from a pure sine wave signal.

If the receiver input impedance is nearly 50 - 100 ohms, a 10 to 20 pf capacitor can be used to couple the high frequency harmonic to the receiver input and to attenuate the lower fundamental frequency. If the receiver has a high input impedance with unshielded lead-in wire from the antenna, the harmonic signal can be loosely coupled to the receiver input by wrapping a few turns of an insulated wire around the antenna lead-in and connecting it directly to the output of the oscillator.

Using harmonics of the oscillator being calibrated makes it necessary to learn the relationship between the oscillator error and the beat note that is measured during calibration. Let the oscillator output be designated as f_F . This is made up of two components, the fundamental frequency plus an error which we can designate as f_0 and f . So:

$$f_F = f_0 + \Delta f \quad (1)$$

This is multiplied N times and beat against the carrier, f_C . The resulting beat note f_B is the difference between the two, written as:

$$f_B = |f_C - Nf_F|. \quad (2)$$

The bars mean that a negative answer is ignored.

Now substitute equation (1) into equation (2):

$$f_B = |f_C - Nf_0 - N\Delta f_F|. \quad (3)$$

But Nf_0 equals f_C . That's why we multiplied by N. So,

$$f_B = N\Delta f_F, \quad (4)$$

or

$$\Delta f_F = f_B/N \quad (5)$$

For example, if a beat frequency of 100 Hz was measured between the WWV 5 MHz signal and the 50th harmonic of a 100 kHz oscillator signal, the frequency error of the 100 kHz signal would be:

$$\Delta f_F = \frac{100 \text{ Hz}}{50} = 2 \text{ Hz.}$$

The oscillator frequency is in error by 2 Hz. To determine whether the oscillator is high or low in frequency, the oscillator frequency has to be changed to note which way the beat frequency decreases. If increasing the oscillator frequency decreases the beat note, it indicates that the oscillator frequency is lower than the WWV/WWVH frequency.

CAUTION: In a receiver with no tuned RF amplifier between the mixer stage and the antenna input, a low frequency sine wave signal can enter the mixer stage and generate unwanted harmonics and confusing beat notes due to the non-linear characteristics of a mixer circuit. However, a good communication receiver or a WWV receiver generally has tuned RF amplifier stages or preselectors before its first mixer stage. Only the desired beat note from two input signals is produced.

If the beat note is above 50 Hz, headphones, speaker, or a counter can be used. Below that frequency, a dc oscilloscope can be connected to the receiver detector. A signal strength meter can be used and the beats counted visually. The AGC (automatic gain control) should be

disabled, if possible, for the meter fluctuations to be more noticeable. The manual RF gain can be adjusted to compensate for loss of AGC.

To correct the oscillator frequency, the frequency adjustment is turned in the direction which lowers the frequency of the beat note. Between 50 Hz and about 1 Hz, the beat note cannot be heard and the signal strength meter will begin to respond to the beat note as it approaches 1 Hz. As it approaches near zero beat, a very slow rise and fall of the background noise or the WWV audio tone can also be heard on the speaker. The meter effect is much easier to follow. As it approaches zero beat frequency, the very slow rise and fall of the signal strength may sometimes become difficult to distinguish from signal fading due to propagation.

To overcome fading effects, the oscillator adjustment can be interpolated. First, adjust the oscillator to minimum beat frequency that can be measured without interference. For accuracy, count the number of deflections of the meter in 10 seconds. The setting of the frequency adjustment is then marked. The adjustment is then made to pass zero beat until the beat is again visible on the meter. By obtaining the same number of meter deflections as the previous beat note, the frequency can be set midway between the two adjustments.

Crystals drift in frequency with age. This is commonly referred to as aging or drift rate. Therefore, all crystal oscillators must be recalibrated periodically.

4.3 Oscilloscope Lissajous Pattern Method of Frequency Calibration

Audio oscillators can be calibrated by using WWV/WWVH signals to produce phase patterns on an oscilloscope. These patterns are called Lissajous (after their originator). The WWV audio signal is applied to the vertical input of the scope and the oscillator signal to be calibrated is used to drive the horizontal amplifier. The resultant pattern tells the user two things: (1) the frequency ratio between his oscillator setting and the received tone, and (2) movement in phase of the oscillator relative to WWV.

In a typical application, the user will be able to check the accuracy of the dial settings on his audio oscillator in a two-step operation. First, he picks a dial setting giving a frequency ratio to a WWV tone that is an integer. Then he turns the dial slowly until the pattern is stationary. By reading the dial setting, a calibration can be made and the dial reset to another frequency that is an integer ratio, etc. The same technique could be applied to fixed frequency sources if they are in correct ratio to the tones on WWV and WWVH. The ratio of the two frequencies is equal to the ratio of the number of loops along two adjacent edges. If the vertical input frequency is known, the horizontal input frequency can be expressed by the equation:

$$f_h = \frac{N_v}{N_h} f_v,$$

Where: f_h = horizontal input frequency
 f_v = vertical input frequency
 N_v = number of loops on the vertical edge
 N_h = number of loops on the horizontal edge

The pattern shown in figure 14 has five loops on the horizontal edge and six loops on the vertical edge. The vertical input frequency is the WWVH 500 Hz tone. To determine the horizontal input frequency, the known values are substituted in the above equation and the result is:

$$f_h = \frac{6}{5} \times 500 = 600 \text{ Hz.}$$

Therefore, the horizontal input frequency is 600 Hz.

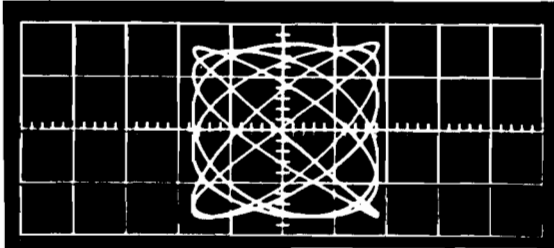

Figure 14. Oscilloscope display showing Lissajous pattern

Vertical Input: WWVH 500 Hz tone
Horizontal Input: Audio oscillator 600 Hz tone

It is possible to calibrate over a ten to one range in frequency both upwards and downwards from the 500 and 600 Hz audio tones transmitted by WWV and WWVH; that is from 50 Hz to 6 kHz. However, not all frequencies between them can be calibrated with the 500 and 600 Hz tones because not all frequencies have a ratio of integers with less than the number ten in the numerator and denominator. For example, a frequency of 130 Hz compared with the 500 Hz tone would give a ratio of 50:13. It would be impossible to count 50 loops on the horizontal edge. But a frequency ratio of 500 Hz to 125 Hz is possible because there will be four loops on the horizontal edge and only one loop on the vertical edge or a ratio of 4:1. A ratio of 1:1 produces a less complex pattern of a tilted line, circle or ellipse.

If the frequencies are exactly equal, the figure will remain stationary. If one frequency is offset from the other, the figure will not remain stationary and will "rotate." Because one complete "rotation" of the figure is equal to one cycle, the number of cycles per unit of time is the offset frequency.

For example: If a Lissajous figure takes ten seconds to "rotate" through one cycle and the frequency being compared is 600 Hz, the frequency error is:

$$\Delta f = \frac{1}{T} = \frac{1}{10} = 0.1 \text{ Hz}$$

$$\text{Offset} = \frac{\Delta f}{f} = \frac{0.1}{600} = 1.7 \times 10^{-4}.$$

Since the offset is inversely proportional to the time it takes to complete one cycle, it is obvious that the longer it takes to complete a cycle, the smaller the offset will be.

The accuracy of measurement of a Lissajous pattern by the comparison method described above is inversely proportional to the frequency. For example, if the time required for a Lissajous figure to "rotate" through one cycle is ten seconds at a frequency of 1 MHz, the offset between the two frequencies would be:

$$\text{frequency offset} = \frac{\Delta f}{f} = \frac{0.1 \text{ Hz}}{1 \times 10^6 \text{ Hz}} = 1 \times 10^{-7}.$$

However, at 1 kHz, if the two signals have the identical frequency offset of 1×10^{-7} , the time it would take for the Lissajous figure to complete one cycle would be:

$$\Delta f = f \times \text{offset} = 1 \times 10^3 \times 1 \times 10^{-7} = 10^{-4} \text{ Hz}$$

$$T = \frac{1}{\Delta f} = \frac{1}{10^{-4}} = 10,000 \text{ seconds.}$$

Thus, it would take too long to measure signals with offsets less than 1×10^{-5} at 1 kHz. A more accurate method which measures the phase shift on an oscilloscope will be discussed next.

4.4 Oscilloscope Pattern Drift Method of Frequency Calibration

The oscilloscope pattern drift method is a good method of comparing two frequencies using an oscilloscope with external triggering. It can detect smaller frequency offsets than the Lissajous pattern at audio frequencies.

The method consists of an oscilloscope with an accurately calibrated sweep time base. External triggering is obtained from the audio signal to be calibrated. This signal can be any integer submultiple of the tone being received from WWV/H. Obviously, for low frequency sources the sweep rate will decrease proportionately. The receiver (tuned to WWV) has its audio output connected to the vertical input of the oscilloscope. With the sweep rate set at 1 millisecond/division, the trigger level is adjusted so that a zero crossover of the corresponding 600 Hz or 500 Hz signal is near midscale on the scope.

By measuring the phase shift during a given time interval, the frequency offset is determined. If the zero crossover moves to the right, the audio signal frequency is higher than the WWV signal, and if it moves to the left, the signal is lower in frequency (figure 15).

For example, if during a count of 10 seconds at 500 Hz, the zero crossover advanced from left to right by 0.1 millisecond, the offset is:

$$\text{Offset} = \frac{\text{phase shift}}{\text{time interval}} = \frac{+0.1 \times 10^{-3}}{10} = +1 \times 10^{-5}$$

$$\Delta f = f \times 1 \times 10^{-5} = 500 \times 10^{-5} = +0.005 \text{ Hz.}$$

Therefore, the 500 Hz signal has an error of +0.005 Hz. Under ideal conditions, an offset of 1 part in 10^6 can be determined by increasing the observation time.

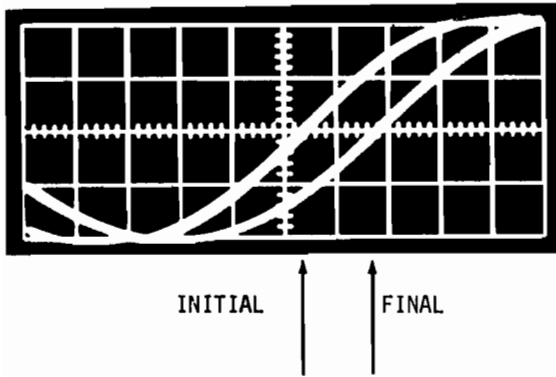

Figure 15. Oscilloscope display using pattern drift method

Vertical signal: WWVH 600 Hz
 Trigger: audio oscillator 600 Hz
 Sweep rate: 100 microseconds/division
 Initial zero crossover: 530 microseconds
 Final zero crossover: 680 microseconds
 Period of measurement: 10 seconds
 Total phase shift: +150 microseconds

$$\text{Offset} = \frac{+150 \times 10^{-6}}{10} = +1.5 \times 10^{-5}$$

$$\Delta f = 600 \times 1.5 \times 10^{-5} = 900 \times 10^{-5} = +0.009 \text{ Hz.}$$

4.5 Frequency Calibrations by Time Comparison of Clocks

The results of daily time checks with WWV and WWVH can be used to calibrate a frequency standard. Frequency offset greater than 1 part in 10^9 can be determined with a resolution of 1 part in 10^{10} . The resolution and accuracy are dependent on signal conditions and the drift rate of the frequency standard.

By averaging time comparison results, errors caused by the ionospheric conditions can be reduced. The technique depends on having a stable frequency standard with negligible drift rate. In other words, the frequency offset must be kept nearly constant during the long period required to average the results of time comparisons. For example, if a quartz crystal oscillator has a known drift rate of +5 parts in 10^{11} per day, then the frequency offset would increase by 1 part in 10^{10} every two days.

To offset this increase, the oscillator is adjusted by 1 part in 10^{10} every two days so its average frequency offset can be maintained nearly constant. The oscillator must have a frequency dial calibrated in divisions of 1 part in 10^{10} or smaller so that a known amount of adjustment can be made at regular intervals to offset the drift rate.

The time comparison method measures frequency indirectly. If a clock controlled by a precision oscillator gains in time with respect to WWV, then the oscillator frequency is higher than the frequency that controls the clocks at WWV and WWVH.

The average frequency of an oscillator during the period between two measurements can be calculated. An adjustment can then be made to keep the average frequency nearly constant.

The average fractional frequency offset of an oscillator is equal to the fractional time error of a clock driven by that oscillator and is given by:

$$\frac{\Delta f}{f} = \frac{t_2 - t_1}{T},$$

Where: $\frac{\Delta f}{f}$ = average frequency offset
 t_1 = initial time comparison reading
 t_2 = final time comparison reading
 T = elapse time between readings.

The average frequency of the oscillator during the measurement interval is given by:

$$f_{av} = f_{nom} \left(1 + \frac{\Delta f}{f}\right),$$

Where: f_{av} = average frequency
 f_{nom} = nominal oscillator frequency
 $\frac{\Delta f}{f}$ = average frequency offset

EXAMPLE: An oscillator with an output frequency of 100 kHz is to be measured with respect to WWV by the time comparison method. The frequency is regularly adjusted to compensate for drift rate of the oscillator. A 1 pps time signal is generated from the 100 kHz signal and compared to WWV. It is then determined that the time increased by one millisecond in ten days.

The average frequency offset is calculated as follows:

$$\frac{\Delta f}{f} = \frac{t_2 - t_1}{T} = \frac{1 \text{ ms}}{10 \text{ days}} \times \frac{1 \text{ day}}{8.64 \times 10^4 \text{ s}}$$

$$\frac{\Delta f}{f} = \frac{10^{-7}}{10 \times 8.64} = +1.2 \times 10^{-9}$$

The oscillator frequency is higher than WWV by 1.2 parts in 10^9 . This means that for a count of 1 billion cycles of its 100 kHz signal, the oscillator will gain 1.2 cycles.

The average frequency of the 100 kHz oscillator signal is calculated as follows:

$$f_{av} = f_{nom} \left(1 + \frac{\Delta f}{f}\right)$$

$$f_{av} = 100,000 (1 + 1.2 \times 10^{-9})$$

$$f_{av} = 100,000 + 0.00012$$

$$f_{av} = 100,000.00012 \text{ Hz.}$$

5. RESULTS OF TIME COMPARISONS

This section gives some results of time comparisons between the station clock at WWVH in Hawaii and the received 15 MHz signal from WWV in Fort Collins, Colorado. The time kept at WWVH has an accuracy of ± 5 microseconds with respect to the time transmitted from WWV. The estimated resolution of each timing measurement was ± 50 microseconds. The delayed trigger method was used to measure the propagation delay.

Measured data for a one month period are listed in Table 1 and show that for \pm one standard deviation* (68% of all data points), measurement accuracy is \pm 142 microseconds (\pm 50 plus \pm 92). If a "moving average" method is used to smooth the data, the results can be improved to \pm 77 microseconds (\pm 50 plus \pm 27). The "moving average" method simply takes the sum of propagation time delay (TD_p) for five consecutive days (column 5 in Table 1), then divides by five to give an average (column 6). This process is repeated for each succeeding day for a "moving average." Column 7 shows the deviation from the moving average mean value.

Figure 16 shows the values in Table 1 plotted along with results of several months' data. Variations of several hundred microseconds do occur, but the moving average does "smooth out" the data and a resultant time base within 100 microseconds can be achieved.

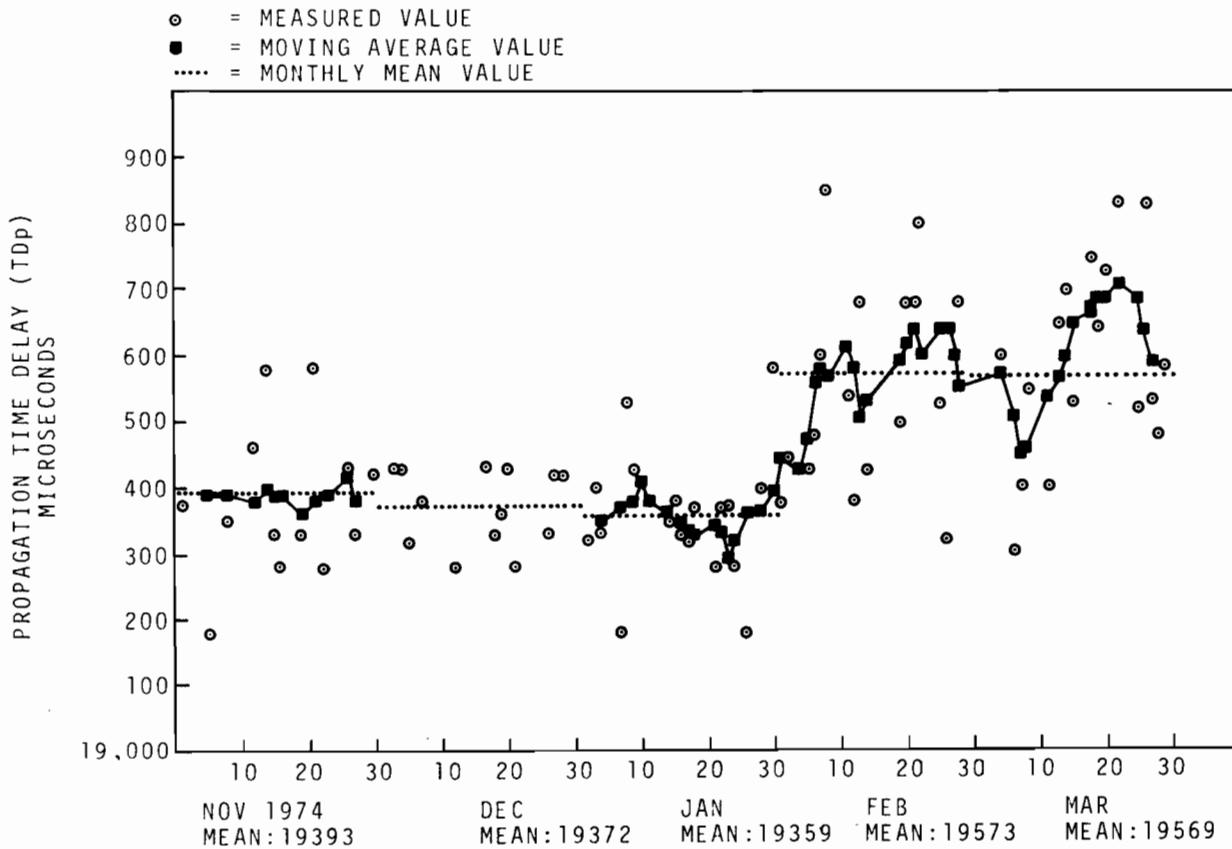

Figure 16. Data plots, propagation time delay (TD_p) between WWV and WWVH.

*Typically a "2 sigma" (\pm 1 standard deviation or 95% of all data points) limit is used in order to have a high level of confidence in a single data point or measurement.

**See "Elementary Statistical Methods," by W. G. Neiswanger, 1946, page 501.

TABLE 1. WWV TO WWVH PROPAGATION DELAY

1974 Jan.	Time UTC	Total Time Delay TD μs	Propagation Time Delay TD_p μs	ΣTD_p (5 values) μs	Moving Average TD_p μs	Deviation from Mean μs
2	1916	20640	19320	-----	-----	---
3	1916	20720	19400	-----	-----	---
4	1920	20650	19330	96760	19352	- 3
7	1916	20500	19180	96870	19374	19
8	1920	20850	19530	96850	19370	15
9	1916	20750	19430	96900	19380	25
10	1917	20700	19380	97070	19414	59
11	1916	20700	19380	96920	19384	29
14	1917	20670	19350	96820	19364	9
15	1915	20700	19380	96760	19352	- 3
16	1918	20650	19330	96750	19350	- 5
17	1916	20640	19320	96680	19336	-19
18	1916	20690	19370	96670	19334	-21
21	1920	20600	19280	96710	19342	-13
22	1910	20690	19370	96670	19334	-21
23	1915	20690	19370	96480	19296	-59
24	1916	20600	19280	96600	19320	-35
25	1916	20500	19180	96810	19362	7
28	1917	20720	19400	96820	19364	9
30	1917	20900	19580	-----	-----	---
31	1920	20700	19380	-----	-----	---
MEAN VALUE:			19359		19355	
STANDARD DEVIATION:			92		27	

Great Circle Distance: 5,500 km (3,417 statute miles)

Time Signal: WWV, 15 MHz

Receiver Delay: 320 μs

Cycle Correction: 1,000 μs

$$\text{TD}_p = \text{TD} - 1,320 \mu\text{s}$$

Having shown that time measurements to about 100 microseconds can be made using WWV/WWVH (or other) HF standard broadcasts, we caution that care must be taken in making the measurements. Averaging methods over several days provide a basis for accurate timekeeping.

6. APPENDIX

6.1. Receiver Selection and Antenna Choices

a. WWV/WWVH Receiver

A commercial shortwave receiver can be used to receive WWV and WWVH signals for time and frequency calibrations. However, for accurate time and frequency calibrations, it is important to have a receiver with optimum sensitivity, selectivity, image rejection, and frequency or phase stability. A block diagram of a typical high performance receiver is shown in figure 17.

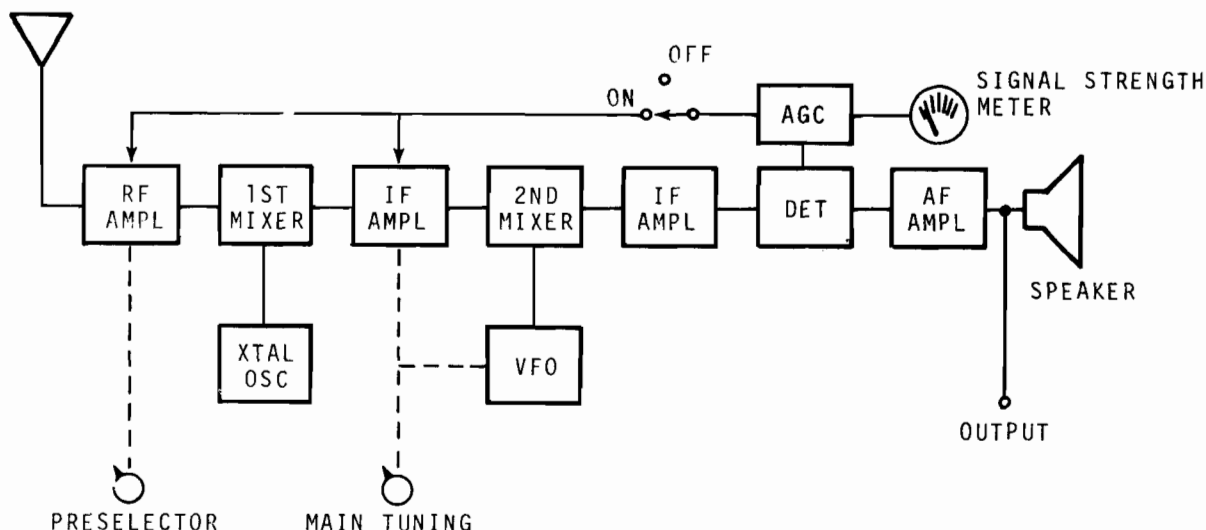

Figure 17. Block diagram of typical high performance HF receiver.

The first requirement of a good receiver is sensitivity; therefore, a tuned RF amplifier is desirable because it increases sensitivity. The amplifier can either be tuned separately (in which case it is called a preselector) or ganged to the main tuning control which also tunes the variable frequency oscillator (VFO).

The next equally important requirement is selectivity. This is the ability of a receiver to reject neighboring signals that interfere with the desired signal. It is accomplished by heterodyning the incoming signal to a much lower fixed frequency (usually 455 kHz) called the intermediate frequency (IF). The IF amplifiers can be fixed-tuned for maximum gain with a relatively narrow frequency pass band. Often, either crystal filters or mechanical filters are used in the IF stages to provide even narrower pass band of frequencies to reject interference.

The third important feature of a good receiver is the ability to reject interference from an undesired signal called the image frequency. Since the IF signal is the difference between the local oscillator frequency and the incoming signal, there are always two different incoming

signals that could produce an IF signal. One is above and the other below the oscillator frequency. For example, a receiver with an intermediate frequency of 455 kHz tuned to WWV at 10.0 MHz would have an oscillator frequency of 10.455 MHz ($10.455 - 10.0 = 455$). However, if another signal with a frequency of approximately 10.910 MHz is present, another "difference" signal of 455 kHz is produced ($10.91 - 10.455 = 455$). Thus, if two signals are separated by twice the intermediate frequency and the oscillator frequency falls between the two signals, an unwanted image signal results.

This situation occurs because the IF signal is low in frequency (i.e., 455 kHz) to the high frequency of the incoming signal (i.e., 10 MHz). Thus, the RF amplifier has insufficient selectivity to reject the interfering signal which is relatively close to the desired signal. In the above example, the unwanted signal is only 0.910 MHz away from 10 MHz and a strong interfering signal can easily pass through the RF stage into the mixer and produce an image IF signal.

To alleviate this situation, a high quality receiver usually employs double conversion or two mixer stages. It heterodynes in two steps to make image rejection easier. The first mixer stage converts the incoming signal to a high intermediate frequency (usually greater than 1 MHz). Any images produced must be separated by more than 2 MHz from the desired signal. For example, if a receiver has a first mixer IF signal of 1.5 MHz, the image signal will be twice the IF signal or 3.0 MHz above the desired signal. Since 3 MHz is now relatively large compared to the incoming signal, the RF stage pass band is usually selective enough to reject the undesired images. For the required additional selectivity, a second mixer stage is added to produce a lower second IF frequency, thus alleviating the image problem.

A crystal local oscillator can be used in these conversion processes to provide frequency stability. A separate first oscillator crystal is required for each frequency to be received. Other information regarding well-designed receivers can be found in such reference materials as the Radio Amateur's Handbook [10].

b. WWV/WWVH Receiving Antennas

Except for those locations near stations such as WWV or WWVH, the signal power as received at great distances may be relatively weak. As the distance is increased, the signal decreases in strength and an antenna with maximum efficiency is often required for best results. Radio waves arrive at different vertical angles, called the wave angle or radiation angle. The wave angle of an arriving signal depends on the distance between the transmitting and receiving station and also on the height of the ionosphere. The closer the receiving station and the higher the ionosphere, the larger the wave angle. Therefore, an antenna must be selected and oriented that favors the wave angle (elevation) as well as the direction (azimuth).

Although radio stations WWV and WWVH transmit on several different frequencies, in most cases, at least one of the frequencies will be received best at a particular location and time of day. In some cases, different frequencies may have to be tried due to varying propagation conditions.

An all-band, log-periodic antenna capable of covering the entire HF band is commercially available. These are used for around-the-clock communication purposes where the entire HF band must be utilized for maximum reliability. However, such an antenna is very large and cumbersome as well as expensive for receiving purposes only. Depending on location, an antenna and a receiver capable of receiving two or more frequencies may be required. Also, if reception of WWV and WWVH is to be conducted both during night and daylight conditions, an additional antenna may be required. Each of the different frequencies transmitted by WWV and WWVH may be received depending upon distance, time of day, month, season, and sunspot cycle. Each frequency will be discussed with the type of antenna most suitable for its reception.

(1) 2.5 MHz. Signals at this frequency have a very short range during the day because of ground wave propagation limitations. Use would be limited to locations within one to two hundred miles from the transmitter. It becomes useful at night, however, especially during the winter season in the higher latitudes where longer nights prevail. Reception is possible over distances of several thousand miles.

The vertical quarter-wavelength monopole antenna has a radiation pattern that favors reception at low wave angles and is very effective in receiving long distance sky wave signals normally arriving at angles of 20 degrees or less. This antenna is not effective for reception of short-range sky wave signals with large wave angles, but it is useful for receiving weak ground wave signals.

For nighttime reception on paths up to several thousand miles, the sky wave is predominant and a horizontal half-wavelength antenna is recommended. The antenna should be located a quarter-wavelength or higher above ground and separated from possible interfering reflecting obstacles. The quarter-wavelength vertical antenna and the half-wavelength horizontal dipole antenna are illustrated in figure 18.

(2) 5.0 MHz. The 5 MHz frequency can be received at greater distances than the 2.5 MHz frequency throughout the day or night, especially during minimum sunspot cycle. Reception is possible up to 1000 miles under ideal conditions, but under normal conditions, daytime propagation conditions limit its useful range. Therefore, reception is usually limited to less than 1000 miles during the day with signals arriving at a wave angle of greater than 20 degrees. During the night, 5 MHz is a very useful frequency for long-range reception except during maximum sunspot cycle. It is excellent during early dawn and early evenings during the winter months when the signal is following the darkness path.

(3) 10.0 MHz. At 10 MHz, reception over great distances is possible during the day and night. It can be classified as an intermediate frequency which again is dependent upon the sunspot cycle. During minimum sunspot cycle, great distances can be covered during the day when the higher frequencies cannot be received. During maximum sunspot cycle, it is probably the best frequency to use during the night when the lower frequencies cannot be heard. During maximum sunspot cycle, reception at 10 MHz is limited to short distances during the day with limitations comparable to those noted at 5.0 MHz. This frequency also provides daytime reception at fairly close range, 200 miles or so, and can effectively be used when 5 MHz reception is poor. Therefore, the half-wavelength horizontal antenna should be selected for close range stations.

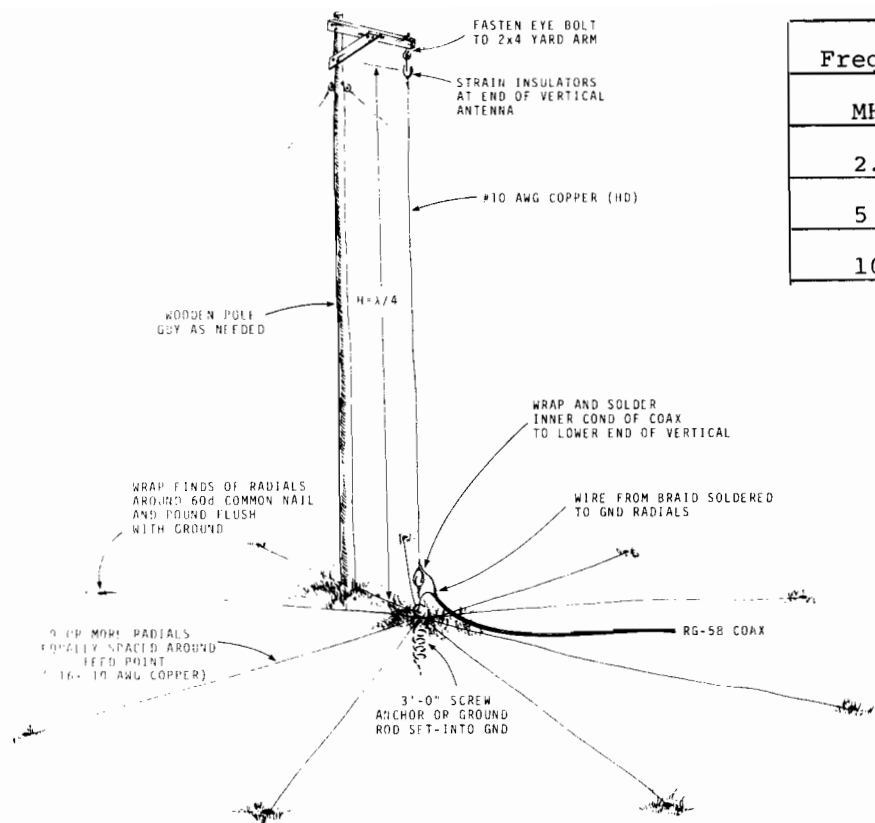

Frequency	1/4 λ Vertical Antenna
MHz	H
2.5	94'-7"
5	46'-10"
10	23'-6"

Figure 18. Quarter-wavelength vertical antenna & horizontal half-wavelength antenna.

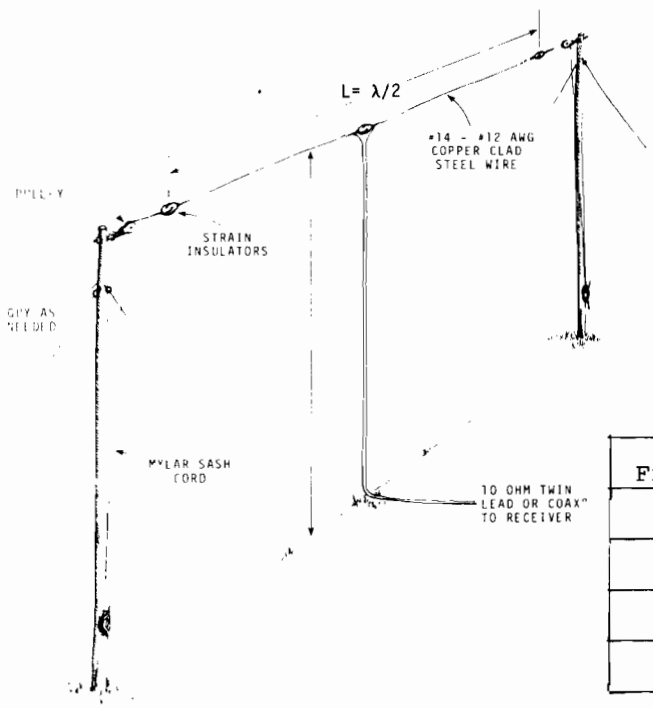

Frequency	1/2 λ Horizontal Dipole Antenna	
	L	H
2.5	187'	50' to 100'
5	93'-7"	30' to 50'
10	46'-10"	25' to 50'

(4) 15.0 MHz. The 15.0 MHz frequency is the most favorable frequency for long range, daytime reception. It is not usable for short-range reception except during periods of sunspot maximum. However, for long range reception, it is the most favored frequency during both sunspot cycle conditions. Under average conditions, the maximum wave angle is limited to 30 degrees or less depending on the density of the ionized layer. During maximum sunspot cycle, reception may even be possible during the night in some locations. During minimum sunspot cycle, it is useful only during the daylight hours and dawn and dusk periods.

The vertical antenna which is favorable to low wave angle reception is preferable to the horizontal half-wavelength antenna and can readily be constructed as shown in figure 19. The dimension of the ground radials and orientation as shown should be used to yield approximately a 50 ohm antenna impedance. For a 70 - 90 ohm antenna, the half-wavelength dipole mounted vertically will yield approximately the correct impedance. In order to prevent interaction between the feed line and the lower half of the dipole, which disturbs the radiation pattern, extend the feed line horizontally outward several feet from the antenna before dropping it vertically to the ground.

(5) 20.0 MHz. The 20 MHz frequency is normally the best to use for daytime reception and will be optimum at either noon or a few hours past noon. Signals at this frequency arrive at very low wave angles and are useful only for long distance reception. During minimum sunspot cycles, reception is poor but improves during the winter. During maximum sunspot cycles, the reception is excellent at night and during the day. The vertical dipole which favors low wave angle radiation has been used at this frequency with favorable results. Construction details for a 20 MHz antenna are shown in figure 19.

(6) 25.0 MHz. The 25 MHz frequency is best during daylight hours except during the summer season. Reception is especially good during maximum sunspot cycle and very poor during minimum sunspot cycle. It is used only for long distance reception due to the low radiation angle required for the signal to be returned back to the earth from the ionosphere. Design details of a different vertical antenna for use at this frequency are also shown in figure 19.

(7) Directional Antenna. The vertical quarter and halfwave antennas are omnidirectional in that they receive signals over 360 degrees in azimuth. The horizontal halfwave dipole, on the other hand, is bidirectional. For greater directivity and increased gain, which limits noise and interference from unwanted signals in other than the desired direction, it is recommended that the Yagi or beam antenna be used. A typical Yagi antenna design is shown in figure 20.

At 15 MHz and below, the length of the Yagi antenna elements become extremely long. A modified Yagi results when coils or inductors are inserted in the elements to increase the effective electrical length. The antenna can then be made to resonate using elements of shorter physical length. Despite the resulting decrease in effective parasitic element length, the modified Yagi antenna has a greater directivity than the half-wavelength dipole antenna. However, it does not compare in gain with a full-sized Yagi. A full-sized five-element Yagi has a power gain of 9.2 db over a half-wavelength dipole at the same height above ground.

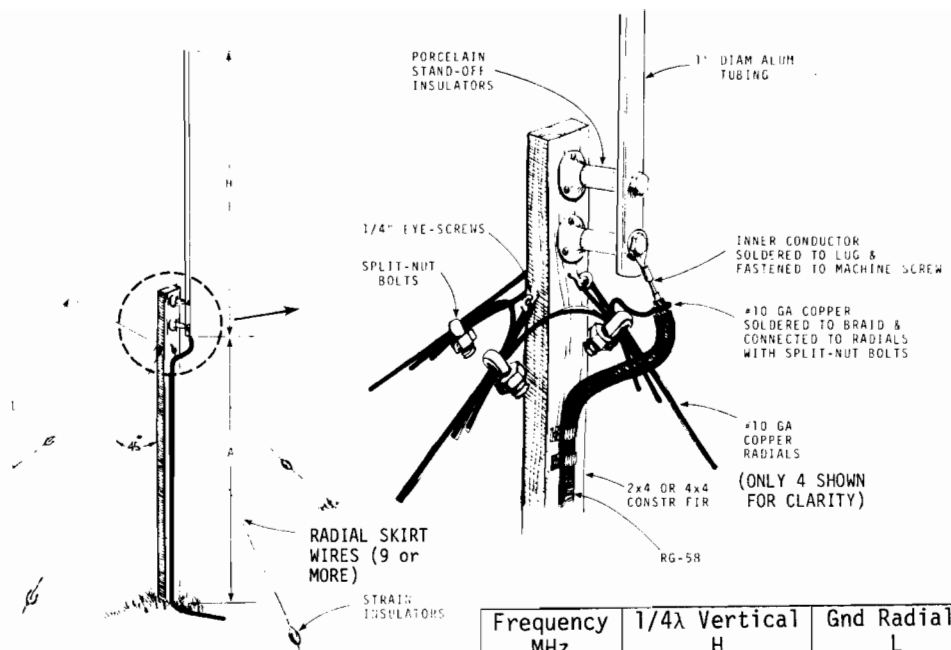

Frequency MHz	1/4λ Vertical H	Gnd Radial L	Height A
15	15'-7"	16'-5"	18'
20	11'-9"	12'-4"	13'
25	9'-5"	9'-10"	11'

Figure 19. Modified half-wavelength vertical antenna for use at 15, 20, and 25 MHz.

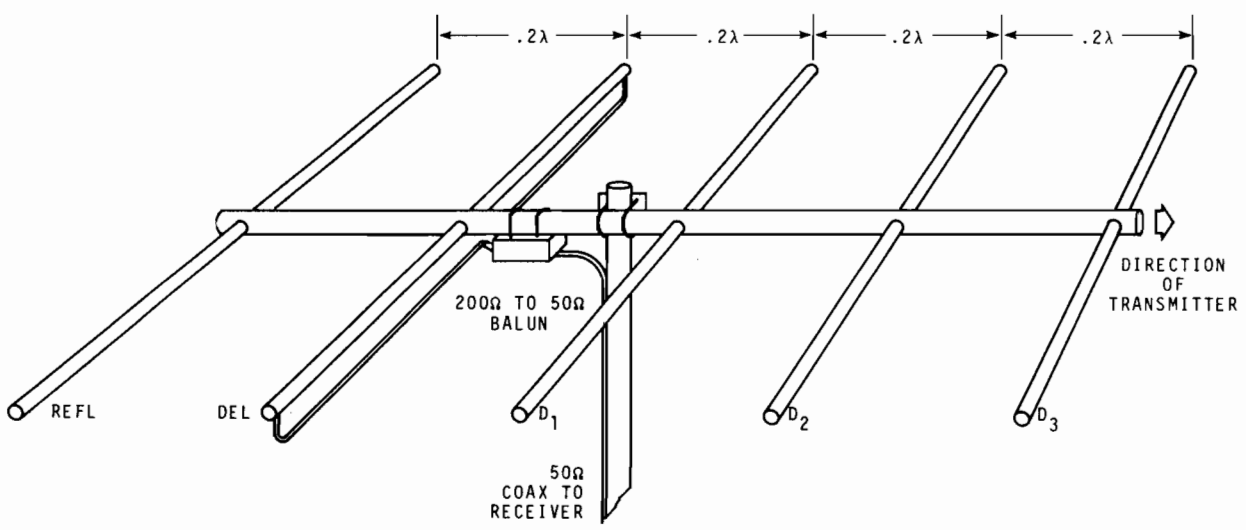

REFLECTOR LENGTH = .490λ
 DRIVEN ELEMENT LENGTH = .465λ
 DIRECTOR 1 = .452λ
 DIRECTOR 2 = .449λ
 DIRECTOR 3 = .452λ
 BOOM DIAMETER 2"
 ELEMENT DIAMETER 1"

Figure 20. Typical Yagi antenna design

6.2. Receiver Time Delay Measurements

To measure the receiver time delay, the following equipment is required: (1) oscilloscope with accurately calibrated, externally-triggered, sweep time scale, (2) HF signal generator, and (3) audio signal generator. The equipment is connected as shown in figure 21.

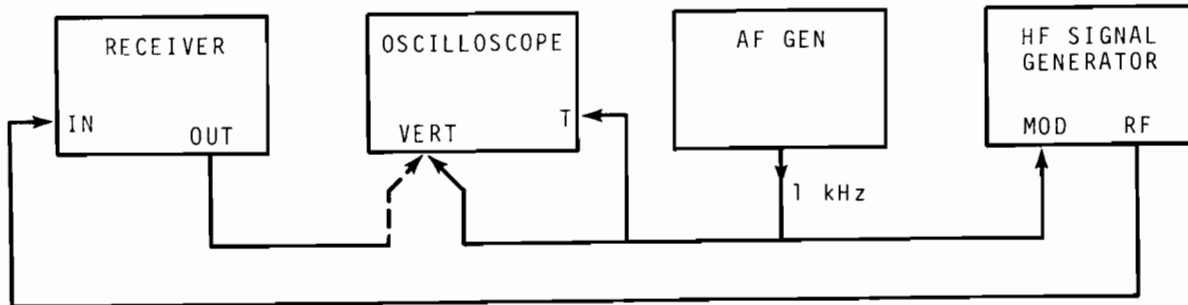

Figure 21. Equipment setup for receiver time delay measurements.

The main tuning dial of the receiver should be set at the exact position for receiving WWV/WWVH signals. This is because the receiver delay time varies appreciably with slightly different receiver dial positions. Therefore, the receiver tuning should be set and marked where the maximum WWV/WWVH signal is received. The frequency of the HF signal generator is then adjusted for peak output of the receiver.

The audio signal generator is set to a 1 kHz output frequency. High accuracy is not required of the 1 kHz signal. The HF generator is externally modulated by the 1 kHz signal. The oscilloscope sweep rate is set to 100 microseconds/division with positive external triggering from the undelayed 1 kHz signal. The vertical amplifier gain is set for large vertical deflection. The vertical position control is adjusted for zero baseline with no vertical input signal.

Initially, the undelayed 1 kHz signal is connected to the vertical input of the oscilloscope. The trigger level control is adjusted so that the trace crosses over or touches the horizontal center line at the left. The horizontal position control can be adjusted so that the signal crosses over the first division on the left as shown in figure 23. The crossover point of the undelayed signal will serve as the zero delay reference point.

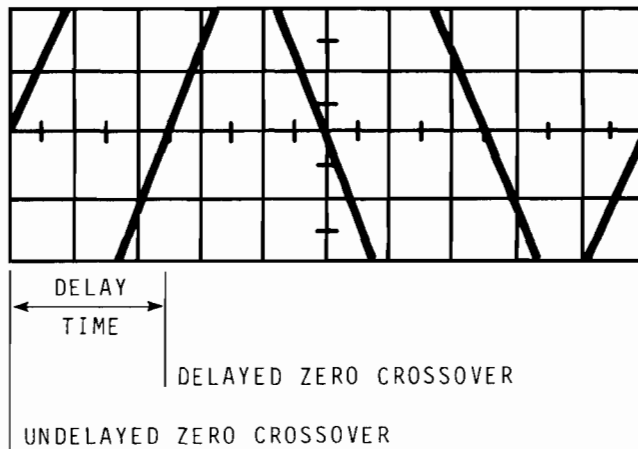

Figure 22. Oscilloscope of delayed and undelayed 1 kHz signal.

Without touching any of the oscilloscope controls, the 1 kHz undelayed signal is disconnected from the vertical input and replaced with the delayed 1 kHz signal from the receiver output. Since a receiver delay is almost always less than 1 millisecond (1 cycle of a 1 kHz signal), there is little chance of ambiguity on which cycle to measure. The delay is equal to the sweep time from the reference undelayed crossover to the first delayed crossover point.

If the delayed signal is found to be inverted and of opposite phase to the reference 1 kHz signal, the receiver has an inverted output signal. However, the receiver delay time remains unchanged and the only difference will be that the output seconds pulse will be inverted with a negative leading edge. For receiver delay of less than 500 microseconds, the sweep rate can be set at 50 microseconds/division.

This technique is a way of locally producing a signal that approximates the timing signal. It is at the same frequency on the dial, uses the same tone frequency, etc. A two-channel scope is very useful since you can then display the tone before it enters the signal generator and after it comes out of the receiver. A study of the block diagram will no doubt suggest other variations on this technique to the user.

6.3 Great Circle Distance Calculations

Using figure 24 as a reference:

A and B are two points on the earth.

P is one of the two poles, North or South.

L_A = Latitude at point A.

L_B = Latitude at point B.

L_{OA} = Longitude at point A.

L_{OB} = Longitude at point B.

$P = L_{OA} - L_{OB}$.

PROBLEM: Using the above information, find the great circle distance (dg) in nautical miles between the two points A and B.

For points A and B on the same side of the equator:

$$dg = 60 \cos^{-1} (\cos L_A \cos L_B \cos P + \sin L_A \sin L_B).$$

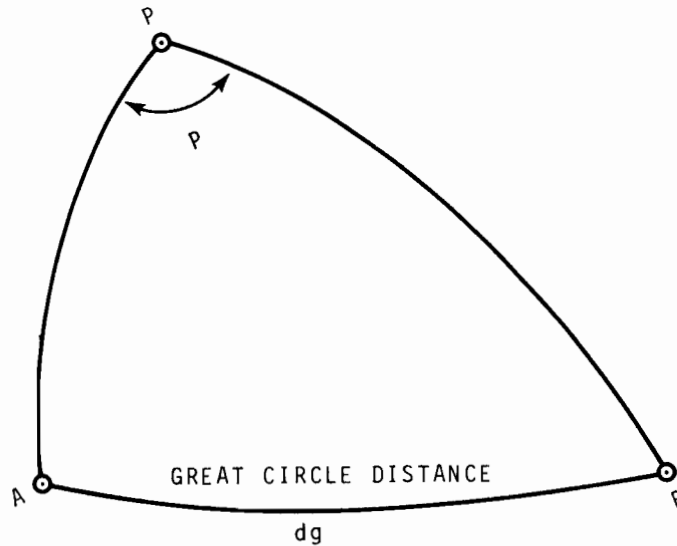

Figure 23. Diagram for great circle distance calculations.

For points A and B on opposite sides of the equator:

$$dg = 60 \cos^{-1} (\cos L_A \cos L_B \cos P - \sin L_A \sin L_B).$$

CONVERSION TO STATUTE MILES AND KILOMETERS:

$$dg = 1.151 \times \text{nautical miles} = \text{statute miles}.$$

$$dg = 1.8522 \times \text{nautical miles} = \text{kilometers}.$$

EXAMPLE: Find the great circle distance from radio station WWVH, Kauai (point A) to WWV, Fort Collins (point B) in statute miles and kilometers.

COORDINATES OF THE TWO STATIONS:

<u>Latitude</u>	<u>Longitude</u>
$L_A = 21^\circ 59' 26'' \text{N}$	$L_{OA} = 159^\circ 46' 00'' \text{W}$
$L_B = 40^\circ 40' 49'' \text{N}$	$L_{OB} = 105^\circ 02' 27'' \text{W}$
$P = 159^\circ 46' 00'' - 105^\circ 02' 27'' = 54^\circ 43' 33''$	

SOLUTION: Taking the sine and cosine:

$$\begin{aligned} \sin L_A &= 0.37445 & \cos L_A &= 0.92725 \\ \sin L_B &= 0.65184 & \cos L_B &= 0.75836 \\ \cos P &= 0.57749 \end{aligned}$$

$$\begin{aligned}
d_g &= 60 \cos^{-1} [(0.92725 \times 0.75836 \times 0.57749) + (0.37445 \times 0.65184)] \\
&= 60 \cos^{-1} [(0.40608) + (0.24408)] \\
&= 60 \cos^{-1} 0.65017 = 60 \times 49.44586 \\
&= 2966.75 \text{ nautical miles} \\
&= 3414.73 \text{ statute miles} \\
&= 5495.0 \text{ kilometers}
\end{aligned}$$

6.4 Propagation Delay Computations

The delay of HF radio waves over a particular radio path depends upon the height of the ionosphere and the distance between the receiver and transmitter (see figure 24). Although heights of the different layers such as the E layer (approximately 110 km), the F₁ layer (approximately 200 to 300 km), and the F₂ layer (approximately 250 to 450 km) can be predicted, they vary in height throughout the day as well as seasonally.

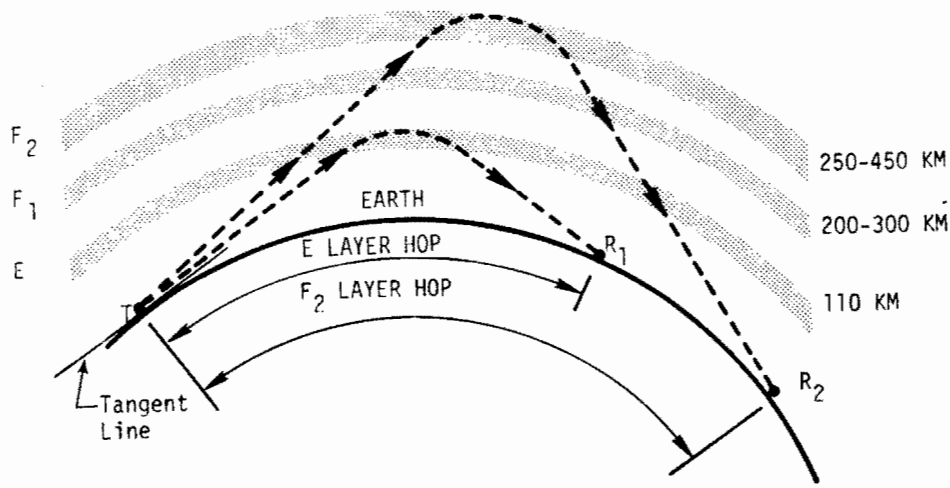

Figure 24. Reflection of radio waves at different ionized layer heights.

The F₁ layer does not exist during the winter months in the northern latitudes. The F₂ layer is most commonly used during the daytime. It reaches a maximum height of 450 km during the summer and a minimum of 250 km during the winter. The F₁ and F₂ layers merge at night to about 300 km in height and remain relatively stable until sunrise.

The E layer, on the other hand, exists during the daytime only and can provide HF propagation to distances of a thousand miles or so. Propagation delay time measured over a particular E-layer path can be readily distinguished from that measured when another layer predominates because the E layer is considerably lower in height.

Errors in determining propagation delay over a particular path are due to the varying heights of the different layers. As the distance between the transmitter and receiver increases, the effective reflecting ionosphere height becomes proportionately lower. At large distances, then, the signal traversed over the sky wave mode approximates the ground path length between the two stations.

EXAMPLE: Assume a transmitter and receiver are spaced one mile (1.61 km) apart, and assume an E layer reflecting height of 110 km. For a change of 20 km in layer height, a corresponding variation of almost 40 km would occur in the effective path length. As a result, the propagation time delay change over this path would measure 3.3 microseconds/kilometer x 40 km, or 132 microseconds.

SECOND EXAMPLE: Assume the same layer geometry, but increase the distance between the two points to one thousand miles (1610 km). The propagation time delay change between reflections from the 110 km and the 130 km layer heights is reduced to only 19.8 microseconds. (NOTE: This assumes a flat earth and flat ionosphere and applies only to single-hop transmissions.)

Since the earth is round, there is a maximum ground distance a single hop can span. For greater distances, the radio waves must obviously be reflected a number of times. The error in the wave path computation for one hop must be multiplied by the total number of hops.

For minimum error, the frequency used for reception should be selected for a minimum number of hops. This also results in a stronger signal due to smaller losses. For a reduced number of hops, figure 25 shows that lower vertical take-off angles (called angles of radiation or wave angles) increase the span that a single hop takes.

At any particular distance, the user must select the proper WWV/WWVH frequency so the signal can be received. At certain frequencies, the signal from the transmitter will penetrate the ionosphere and not reflect. Other frequencies will skip over the user. He is then said to be located in the skip distance for that frequency. A lower frequency must be selected (figure 26).

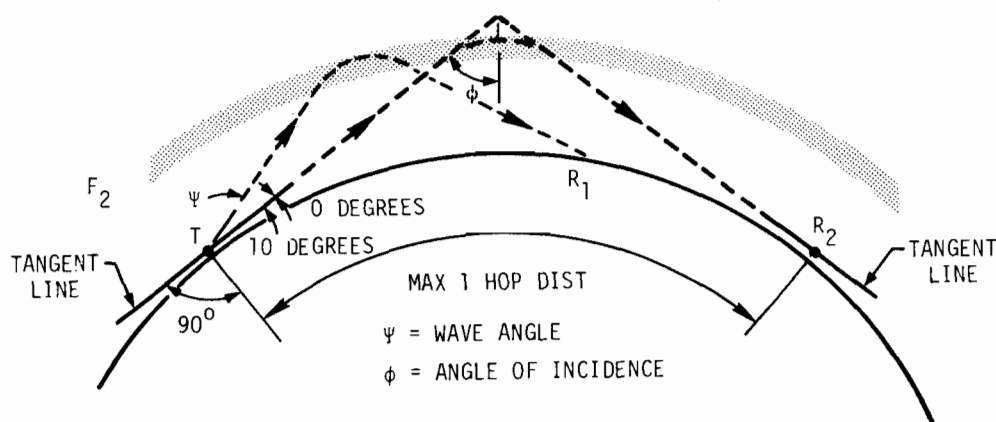

Figure 25. Single-hop reflections from F₂ layer at different wave angles.

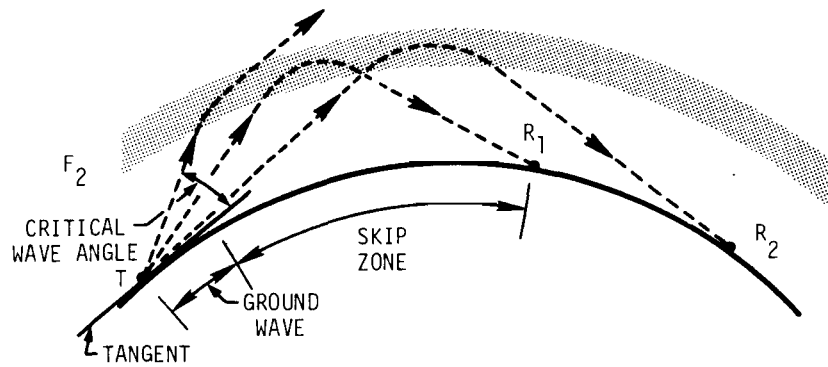

Figure 26. Single-hop transmission at different wave angles.

Use of the maximum frequency that is receivable assures the least number of hops. This maximum usable frequency is called the MUF. For any higher frequency, the signal will skip over the receiving station. A frequency approximately 10% below the MUF will provide the best reception.

Another appreciable error in propagation time delay computations is in estimating the number of hops a signal takes. At distances over one thousand miles, the signal takes several hops depending on the distance. The exact number of hops must be determined because for an error of one hop, the time delay computation can be in error from 500 microseconds to 1 millisecond. Again, by using a frequency near the MUF, a minimum number of hops is assured. Hops with angles of radiation of a few degrees should be neglected in the computation. The next higher number should be used. Angles of less than 5 degrees may not be possible due to interference by mountains or high terrain (figure 27). For signal paths over water, low angles are possible. Therefore, the estimated point where the signal is reflected from the earth and the terrain near the receiver and transmitting sites should be considered to see if low-angle radiation is possible. Because ground wave attenuation is high at HF frequencies, there is an increase in attenuation for very low angles of radiation.

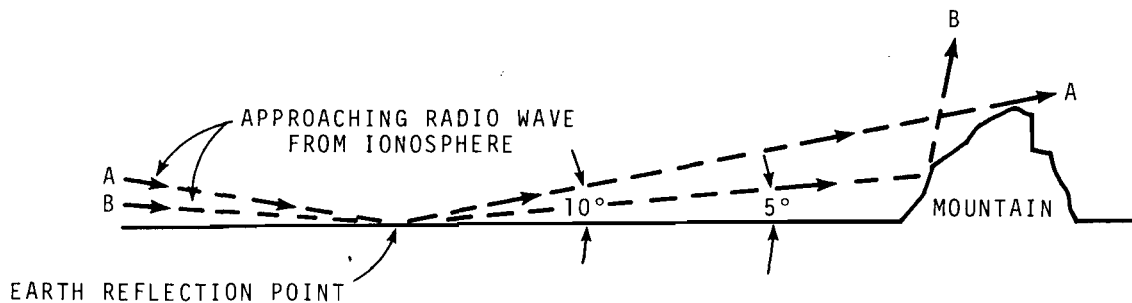

Figure 27. Multihop signal that has a too low angle of radiation.

For distances under one thousand miles, the single-hop mode of transmission dominates. Errors in propagation time delay will increase as the ground distance decreases for the same given error in the estimated height. For short distances, then, the height must be estimated more carefully. For distances of over one thousand miles where only a single-hop mode of transmission occurs, a much wider range of error in the height can be tolerated.

By estimating height according to time of day, season, latitude, and sunspot cycle, errors can be reduced. For F_2 -layer reflections (which is the principle layer used), there are several "averages" in height that can be used. The F_2 -layer height ranges from 250 km to 300 km during the winter months. The height increases as summer approaches and reaches a maximum height ranging from 350 km to 400 km. Selecting an average of 250 km is reasonable for the winter months when propagation conditions are excellent on the upper HF bands (10 MHz and above). As conditions worsen, the layer height usually increases. Thus, an average height can be increased to 350 km. As reception again begins to improve in the fall, the estimated height can be decreased again. Using this approximation method, the error in path length computation can be reduced considerably.

For distances greater than one thousand miles (1610 km) to two thousand miles (3220 km) where multiple-hop transmission occurs, the method above produces multiple errors. For good results, the height must be determined with greater accuracy. Heights for a particular latitude, longitude, and time of day are available from the World Data Center, NOAA, Department of Commerce, Boulder, Colorado 80302.

The layer height has a tendency to vary even at the same time of day. Additional propagation path delay is caused by the retardation or slowing down of the radio wave with partial refraction or bending as it passes through the lower F_1 and E layers during the day (figure 28). The correct layer height and amount of retardation for any given day is impossible to calculate accurately. Only the average height over longer periods can be determined with some certainty.

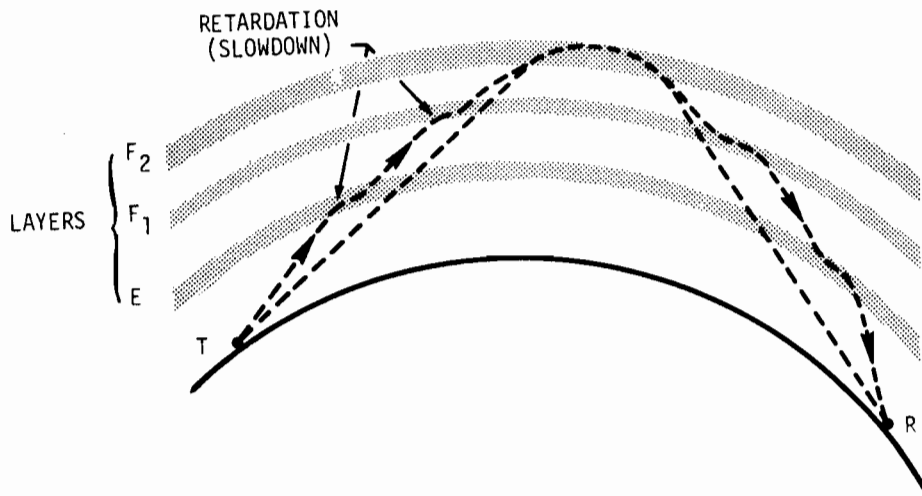

Figure 28. Retardation or slow down of radio waves as they pass through different ionized layers.

DERIVATION OF WAVE ANGLE EQUATIONS

$$\Delta = \tan^{-1} \left(\frac{h'}{R \sin \theta} + \tan \frac{\theta}{2} \right) - \theta$$

$$\theta(\text{degrees}) = \frac{dg}{2RN} \left(\frac{180}{3.14} \right) = 0.0045 \frac{dg}{N}$$

FIRST SIMPLIFIED FORM for $\frac{dg}{N} < 4000$ km or $\theta < 18^\circ$:

$$\Delta = \tan^{-1} \left(\frac{2Nh'}{dg} + \frac{dg}{4RN} \right) - 0.0045 \frac{dg}{N}$$

SECOND SIMPLIFIED FORM for $\theta < 20$ degrees:

$$\Delta \approx \left(\frac{2Nh'}{dg} - \frac{dg}{4RN} \right) 57.3$$

PROPAGATION TIME DELAY

$$TD_p = \frac{2R \sin \theta}{299.8 \sin \phi} = \frac{dg}{299.8 \sin \phi} \quad (R \text{ and } dg \text{ in km})$$

Where:

$$\phi = 90^\circ - \tan^{-1} \left(\frac{h'}{R \sin \theta} + \tan \frac{\theta}{2} \right)$$

GIVEN $\frac{dg}{N} < 4000$ km, $\theta < 18^\circ$:

$$\phi = 90^\circ - \tan^{-1} \left(\frac{2Nh'}{dg} + \frac{dg}{4RN} \right) \quad (\text{approximately})$$

SAMPLE CALCULATIONS

Given: $dg = 3220$ km
 $h' = 250$ km
 $N = 2,$

Determine wave angle Δ and propagation time delay TD_p .

$$\Delta = \tan^{-1} \left(\frac{2Nh'}{dg} + \frac{dg}{4RN} \right) - 0.0045 \frac{dg}{N}$$

$$\Delta = \tan^{-1} \left(\frac{2 \times 2 \times 250}{3220} + \frac{3220}{4 \times 6370 \times 2} \right) - 0.0045 \times \frac{3220}{2}$$

$$\Delta = \tan^{-1} (0.3106 + 0.0632) - 7.3$$

$$\Delta = \tan^{-1} (0.3738) - 7.3$$

$$\Delta = 20.5 - 7.3 = 13.25^\circ.$$

Solving Δ by the approximate method:

$$\Delta \approx \left(\frac{2Nh'}{dg} - \frac{dg}{4RN} \right) 57.3$$

$$\Delta \approx \left(\frac{2 \times 2 \times 250}{3220} - \frac{3220}{4 \times 6370 \times 2} \right) 57.3$$

$$\Delta \approx (0.3106 - 0.0632) 57.3$$

$$\Delta \approx (0.2474) 57.3 = 14.2^\circ$$

$$TD_p = \frac{dg}{299.8 \sin \phi}$$

$$\phi = 90^\circ - \tan^{-1} \left(\frac{2Nh'}{dg} + \frac{dg}{4RN} \right)$$

From the calculated value of wave angle Δ :

$$\tan^{-1} \left(\frac{2Nh'}{dg} + \frac{dg}{4RN} \right) = 20.5^\circ$$

$$\phi = 90 - 20.5 = 69.5^\circ$$

$$TD_p = \frac{3220}{299.8 \sin 69.5} = \frac{3220}{299.8 \times 0.93367}$$

$$TD_p = 11.5 \text{ ms}$$

Given: $dg = 3220 \text{ km}$

$h' = 250 \text{ km}$

$N = 1$

$$\Delta = \tan^{-1} \left(\frac{2Nh'}{dg} + \frac{dg}{4RN} \right) - 0.0045 \frac{dg}{N}$$

$$\Delta = \tan^{-1} \left(\frac{2 \times 1 \times 250}{3220} + \frac{3220}{4 \times 6370 \times 1} \right) - 0.0045 \times \frac{3220}{1}$$

$$\Delta = \tan^{-1}(0.1553 + 0.1264) - 14.5$$

$$\Delta = \tan^{-1}(0.2817) - 14.5 = 15.7 - 14.5$$

$$\Delta = 1.2^\circ$$

Propagation time delay, TD_p :

$$TD_p = \frac{dg}{299.8 \sin \phi}$$

But $\phi = 90 - 15.73 = 74.27^\circ$ and $\sin 74.27 = 0.96253$.

Therefore,

$$TD_p = \frac{3220}{299.8 \times 0.96253}$$

$$TD_p = 11.2 \text{ ms}$$

Because of the low wave angle of 1.2° , a one-hop mode is very unlikely. However, a one-hop mode would be possible with a higher virtual height.

EXAMPLE: For the previous example, what virtual height would be required for a wave angle of 5° ?

SOLUTION:

$$h' = \left[\tan(\Delta + \theta) - \frac{dg}{4RN} \right] \frac{dg}{2N}$$

$$\Delta + \theta = 5 + 14.5 = 19.5^\circ$$

$$h' = \left[\tan 19.5 - \frac{dg}{4RN} \right] \frac{dg}{2N}$$

$$h' = [0.33381 - 0.12637]1610$$

$$h' = 334 \text{ km}$$

The propagation time delay TD_p for $\Delta = 5^\circ$:

$$TD_p = \frac{dg}{299.8 \sin \phi}$$

where:

$$\phi = 90 - (\Delta + \theta),$$

$$\phi = 90 - 19.5 = 70.5, \text{ and}$$

$$\sin 70.5 = 0.94264.$$

Therefore,

$$TD_p = \frac{3220}{299.8 \times 0.94264}$$

$$= 11.4 \text{ ms.}$$

Thus, the time delay of 2 hops at 250 km virtual height and 1 hop at 334 km virtual height will differ only by 100 microseconds.

6.5. Adjustable Time Delay Generator

The adjustable time delay generator is a unit that has an output pulse which is precisely delayed from its input pulse of 1 pps. A 100 kHz input signal to the unit is the timing source. The maximum delay for the unit is 99,990 microseconds (99.99 ms). Four front panel switches are capable of selecting any delay from zero to the maximum delay in steps of 10 microseconds.

Basically, this device is a counter capable of counting up to 9,999. It counts cycles with a period of 10 microseconds. Therefore, the number of counts represent the total time lapse in tens of microseconds. The count is initiated by a reference one pulse per second (1 pps) input from the local master clock. After a preselected number of counts (time delay), a positive pulse appears at the output. Simultaneously, the counters are reset to zero and held until the next 1 pps signal again initiates a count. The output is therefore also a 1 pps signal which has a precise delay with respect to the 1 pps input signal. The theory of operation can be separated into four different functional groups.

a. Decade Counters

The decade counters consist of IC1 through IC4 and decoders IC5 through IC8 (refer to figure 30, Logic Diagram). The first counter IC1 is a unit counter and counts in the unit of tens of microseconds of the 100 kHz input signal. IC12A is a buffer and pulse-shaping amplifier for the 100 kHz input signal. The counter counts whenever the input goes from a high logic "1" to a low logic "0" state only. After a count of ten, the D output of the counter goes from a high to a low state. It is connected to the input of the next counter IC2. Therefore, for each ten counts of counter IC1, counter IC2 has a count of one. Thus, counter IC2 counts in the units of 100 microseconds. Similarly, IC3 counts in units of 1000 microseconds and IC4 in units of 10,000 microseconds. Each of the counters also has three other outputs besides the D output labeled A, B, and C. The combination of the four outputs gives an output count of 0 to 9 in binary coded decimal (BCD) with the A output having a weight of 1, B a weight of 2, C a weight of 4, and D a weight of 8. For example, a count of 5 will have outputs A (1) and C (4) with a logic "1."

To simplify the selection of the count desired, the BCD output is decoded by decimal decoders IC5 through IC8. The output is in the decimal unit with ten outputs from each decoder representing each count 0 to 9. Each output switches from a logic "1" to a logic "0" when the corresponding count is attained.

b. Count Selection and Logic Group

The count selection and logic group selects the number of counts desired and determines when the selected count has been made. It consists of switches SW1 through SW4, negative NAND gates IC9A and 9B, and positive NAND gates IC10A. Switches SW1 through SW4 select one of the 10 output counts of 0 to 9 of the decoder output. The switches can either be the thumbwheel 10-position decimal switches or the rotary 10-position, single-pole switches. When the exact count selected by all four switches has been achieved the outputs of negative NAND gate IC9A and 9B switches the output of positive NAND gate IC10A from a logic "1" to a logic "0." However, IC10A switches to a low state only when all three inputs from IC9A, 9B, and 10B are logic "1." (The purpose of IC10B will be explained later.)

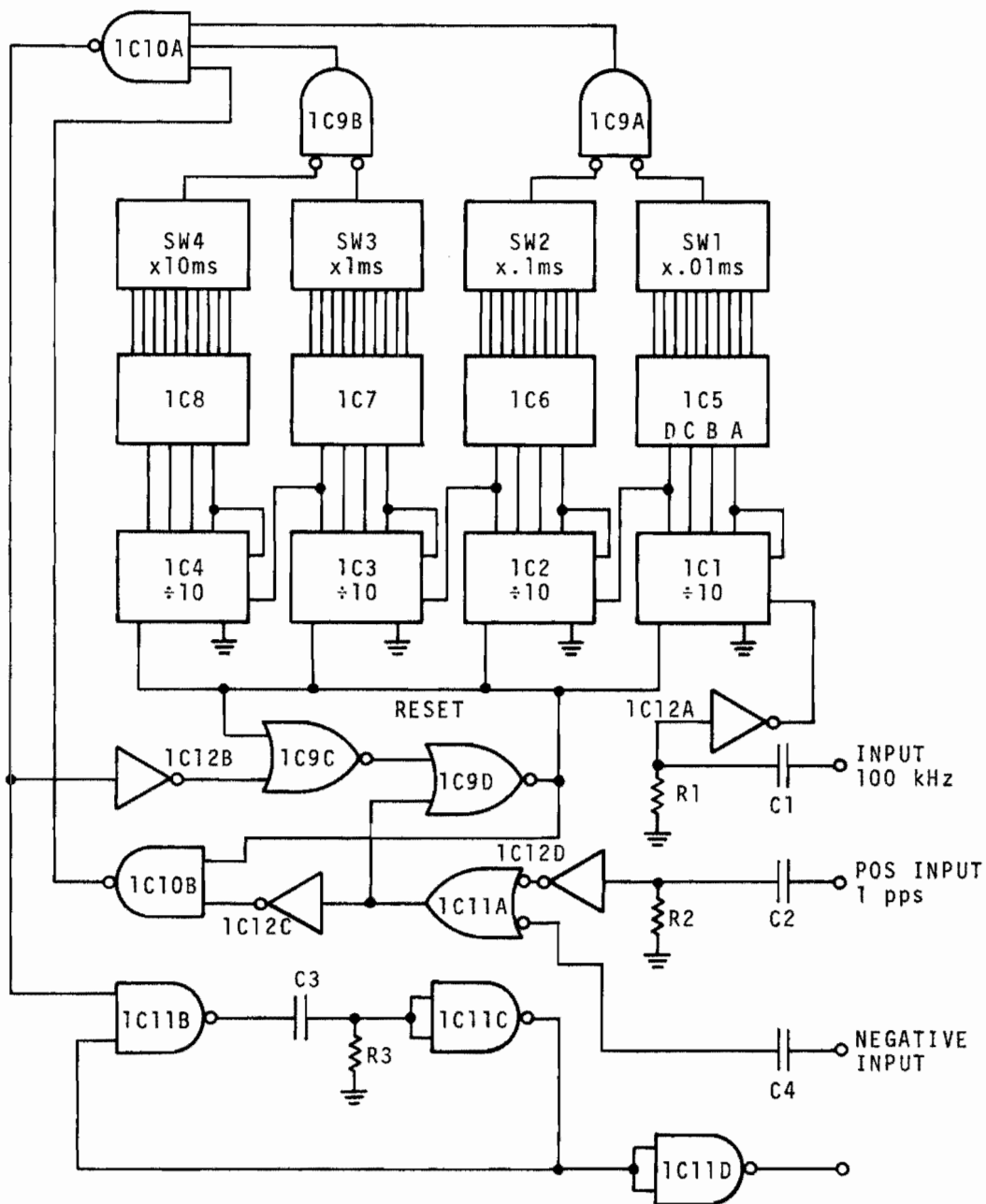

- | | | | |
|-------|---|------|--|
| IC1-4 | 7490 decade counter | IC10 | 7420 dual 4-input positive NAND gates |
| IC5-8 | 7442 decimal decoder | IC11 | 7400 quad. 2-input positive NAND gates or negative NOR gates |
| IC9 | 7402 quad. 2-input positive NOR gates or negative NAND gate | IC12 | Hex inverters 7404 |

Figure 30. Controlled delay generator logic diagram

Therefore, IC10A switches state when the selected number of counts (delay time) has been accomplished. An instant later, IC10A resets.

c. Starting and Resetting Group

This group consists of IC9C, 9D, 10B, 11A, 12B, 12C, and 12D. IC9C and 9D are two positive NOR gates wired together to work as a bi-stable, toggle switch to start and reset the counters. When the output of IC9D, which is connected to the reset inputs of IC1 through IC4, is in the logic "1," the counters are placed in the reset condition with the counter outputs indicating zero count. When IC9D output switches to a logic "0," the counters begin to count. With one of two inputs of NOR gate IC9C connected to the reset line of IC1 to IC4, the output of IC9C always switches to a logic "0" whenever the reset line switches to a logic "1." The output of IC9C is connected to one of the inputs of IC9D. The other input of IC9D is from the negative NOR gate IC11A. Since IC11A is normally in the quiescent logic "0" state, both inputs of IC9D are logic "0" and, therefore, the output remains in logic "1" to keep the counters in the reset and hold condition.

IC11A is a negative NOR gate that always has a logic "0" output except when the 1 pps signal switches it to a logic "1." Both inputs of IC11A are normally in the logic "1" due to resistor R_2 of inverter IC12D which holds the input of the inverter to a logic "0" and the capacitor C_4 which holds the other input of NOR gate IC11A to a logic "1." When a positive 1 pps signal is connected to the positive input, the positive input pulse raises the input of inverter IC12D to a logic "1" and the output to a logic "0." Negative NOR gate IC11A thus switches to a logic "1" which in turn switches the positive NOR gate IC9D to a logic "0" to start the counters. Due to the feedback action of IC9C with IC9D, once the output of IC9D has switched to the logic "0," it remains in that state although the short duration 1 pps pulse has terminated.

Upon completion of the selected delay time, IC10A switches to a logic "0" which is inverted to a logic "1" by IC12B. The logic "1" switches the NOR gate IC9C to a logic "0" which in turn switches NOR gate IC9D to a logic "1," thus stopping and resetting all the counters IC1 to IC4. This in turn also resets the output NAND gate IC10A back to a logic "1."

There is one condition in which IC10A will always remain in logic "0" instead of logic "1," if IC10A did not have an input from IC10B. This occurs when a zero time delay or zero count is desired. To prevent this malfunction, positive NAND gate IC10B assures that IC10A always remains in a logic "1" whenever the counters are in the reset and holding condition. When the output of IC9D is a logic "1," and IC11A is in a quiescent logic "0" state, with both inputs in a logic "1," IC10B has an output of logic "0." (IC12C inverts the logic "0" of IC11A to a logic "1.") The logic "0" output of IC10B thus keeps IC10A in the logic "1" regardless of the output status of IC9A and 9B. When the 1 pps input pulse arrives, it immediately switches IC10B back to a logic "1." The output of IC9D which also switches to a logic "0" keeps IC10B in the logic "1" after the 1 pps pulse has terminated. Thus, output IC10A switches to a logic "0" when IC9A and 9B has a logic "1" output. IC10B is reset back to a logic "0" when IC9D resets to a logic "1."

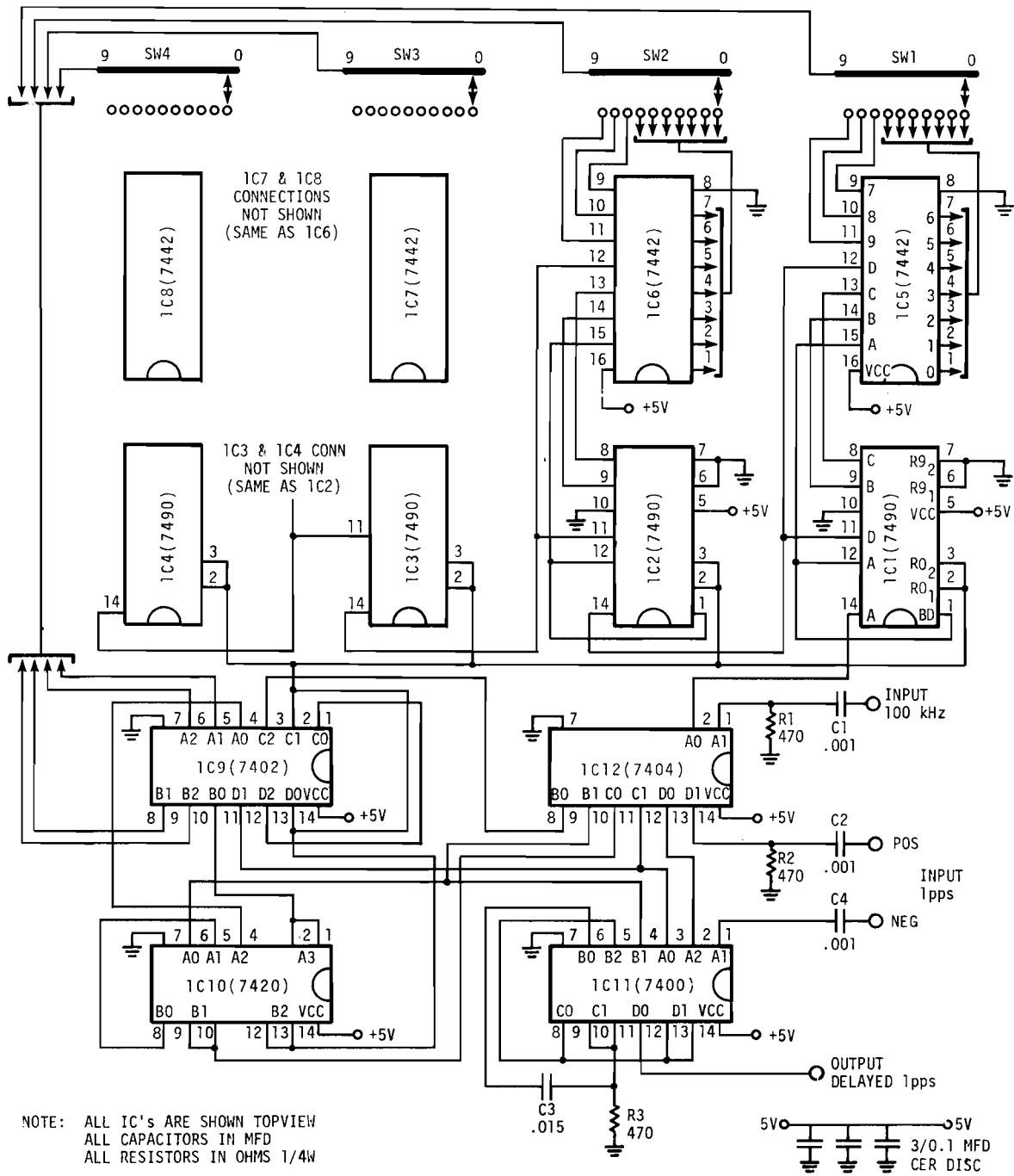

Figure 31. Controlled delay generator wiring diagram

d. Output Pulse Shaping and Inverter Group

The fourth and final group is the output pulse shaping and inverter consisting of positive NAND gate IC11B and IC11C and inverter IC11D. IC11B and IC11C is a one-shot astable multivibrator with a pulse width equal to R_3C_3 . Resistor R_3 also keeps the input of IC11C to a logic "0" in the quiescent state and therefore should be approximately 500 to 600 ohms. A resistance of 500 ohms for R_3 and 0.02 microfarad for C_3 results in a pulse width of about 10 microseconds. Inverter IC11D inverts the negative output pulse of IC11C to a positive output pulse. A wiring diagram is shown in figure 31.

7. ACKNOWLEDGEMENT

The authors thank Peter Viezbicke for his encouragement and support of this work and his comments regarding antennas. The authors also acknowledge with pleasure the assistance given by Judy Rapozo in typing various manuscripts and providing help in the organization of this paper.

8. REFERENCES

- [1] Viezbicke, P. P., NBS Frequency-Time Broadcast Station WWV, Fort Collins, Colorado, Nat. Bur. Stand. (U. S.), Tech. Note 611 (Oct. 1971).
- [2] Viezbicke, P. P., NBS Frequency and Time Broadcast Services, Nat. Bur. Stand. (U. S.), Spec. Publ. 236 (March 1974).
- [3] Milton, J. B., Standard Time and Frequency: Its Generation, Control, and Dissemination by the National Bureau of Standards, Nat. Bur. Stand. (U. S.), Tech. Note 656 (June 1974).
- [4] Morgan, A. H., Precise Time Synchronization of Widely Separated Clocks, Nat. Bur. Stand. (U. S.), Tech. Note 22 (July 1959).
- [5] Blair, B. E. and Morgan, A. H., Control of WWV and WWVH Standard Frequency Broadcasts by VLF and LF Signals, J. Res. Nat. Bur. Stand. (U. S.), 69D (Radio Science), No. 7 (July 1965).
- [6] Frequency and Time Standards, Appl. Note 52, Hewlett-Packard Company (Nov. 1965).
- [7] Blair, B. E. and Morgan, A. H., eds., Nat. Bur. Stand. (U. S.), Spec. Publ. 300, Vol. 5 (June 1972).
- [8] Merrell, R., Keeping Accurate Time with WWV, Broadcast Engrg., 10, No. 9, pp. 1214 (Sept. 1968).
- [9] Johnson, J. R., Precise Measurement of Radio Frequencies, Elec. World, pp. 47-50 (Aug. 1964).
- [10] The Radio Amateur's Handbook, Fiftieth Ed., (Am. Radio Relay League, 1973).

NBS TECHNICAL PUBLICATIONS

PERIODICALS

JOURNAL OF RESEARCH reports National Bureau of Standards research and development in physics, mathematics, and chemistry. It is published in two sections, available separately:

• Physics and Chemistry (Section A)

Papers of interest primarily to scientists working in these fields. This section covers a broad range of physical and chemical research, with major emphasis on standards of physical measurement, fundamental constants, and properties of matter. Issued six times a year. Annual subscription: Domestic, \$17.00; Foreign, \$21.25.

• Mathematical Sciences (Section B)

Studies and compilations designed mainly for the mathematician and theoretical physicist. Topics in mathematical statistics, theory of experiment design, numerical analysis, theoretical physics and chemistry, logical design and programming of computers and computer systems. Short numerical tables. Issued quarterly. Annual subscription: Domestic, \$9.00; Foreign, \$11.25.

DIMENSIONS/NBS (formerly *Technical News Bulletin*)—This monthly magazine is published to inform scientists, engineers, businessmen, industry, teachers, students, and consumers of the latest advances in science and technology, with primary emphasis on the work at NBS. The magazine highlights and reviews such issues as energy research, fire protection, building technology, metric conversion, pollution abatement, health and safety, and consumer product performance. In addition, it reports the results of Bureau programs in measurement standards and techniques, properties of matter and materials, engineering standards and services, instrumentation, and automatic data processing.

Annual subscription: Domestic, \$9.45; Foreign, \$11.85.

NONPERIODICALS

Monographs—Major contributions to the technical literature on various subjects related to the Bureau's scientific and technical activities.

Handbooks—Recommended codes of engineering and industrial practice (including safety codes) developed in cooperation with interested industries, professional organizations, and regulatory bodies.

Special Publications—Include proceedings of conferences sponsored by NBS, NBS annual reports, and other special publications appropriate to this grouping such as wall charts, pocket cards, and bibliographies.

Applied Mathematics Series—Mathematical tables, manuals, and studies of special interest to physicists, engineers, chemists, biologists, mathematicians, computer programmers, and others engaged in scientific and technical work.

National Standard Reference Data Series—Provides quantitative data on the physical and chemical properties of materials, compiled from the world's literature and critically evaluated. Developed under a world-wide

program coordinated by NBS. Program under authority of National Standard Data Act (Public Law 90-396).

NOTE: At present the principal publication outlet for these data is the *Journal of Physical and Chemical Reference Data* (JPCRD) published quarterly for NBS by the American Chemical Society (ACS) and the American Institute of Physics (AIP). Subscriptions, reprints, and supplements available from ACS, 1155 Sixteenth St. N. W., Wash. D. C. 20056.

Building Science Series—Disseminates technical information developed at the Bureau on building materials, components, systems, and whole structures. The series presents research results, test methods, and performance criteria related to the structural and environmental functions and the durability and safety characteristics of building elements and systems.

Technical Notes—Studies or reports which are complete in themselves but restrictive in their treatment of a subject. Analogous to monographs but not so comprehensive in scope or definitive in treatment of the subject area. Often serve as a vehicle for final reports of work performed at NBS under the sponsorship of other government agencies.

Voluntary Product Standards—Developed under procedures published by the Department of Commerce in Part 10, Title 15, of the Code of Federal Regulations. The purpose of the standards is to establish nationally recognized requirements for products, and to provide all concerned interests with a basis for common understanding of the characteristics of the products. NBS administers this program as a supplement to the activities of the private sector standardizing organizations.

Federal Information Processing Standards Publications (FIPS PUBS)—Publications in this series collectively constitute the Federal Information Processing Standards Register. Register serves as the official source of information in the Federal Government regarding standards issued by NBS pursuant to the Federal Property and Administrative Services Act of 1949 as amended, Public Law 89-306 (79 Stat. 1127), and as implemented by Executive Order 11717 (38 FR 12315, dated May 11, 1973) and Part 6 of Title 15 CFR (Code of Federal Regulations).

Consumer Information Series—Practical information, based on NBS research and experience, covering areas of interest to the consumer. Easily understandable language and illustrations provide useful background knowledge for shopping in today's technological marketplace.

NBS Interagency Reports (NBSIR)—A special series of interim or final reports on work performed by NBS for outside sponsors (both government and non-government). In general, initial distribution is handled by the sponsor; public distribution is by the National Technical Information Service (Springfield, Va. 22161) in paper copy or microfiche form.

Order NBS publications (except NBSIR's and Bibliographic Subscription Services) from: Superintendent of Documents, Government Printing Office, Washington, D.C. 20402.

BIBLIOGRAPHIC SUBSCRIPTION SERVICES

The following current-awareness and literature-survey bibliographies are issued periodically by the Bureau: **Cryogenic Data Center Current Awareness Service**

A literature survey issued biweekly. Annual subscription: Domestic, \$20.00; foreign, \$25.00.

Liquefied Natural Gas. A literature survey issued quarterly. Annual subscription: \$20.00.

Superconducting Devices and Materials. A literature

survey issued quarterly. Annual subscription: \$20.00. Send subscription orders and remittances for the preceding bibliographic services to National Technical Information Service, Springfield, Va. 22161.

Electromagnetic Metrology Current Awareness Service Issued monthly. Annual subscription: \$100.00 (Special rates for multi-subscriptions). Send subscription order and remittance to Electromagnetics Division, National Bureau of Standards, Boulder, Colo. 80302.